

## CEEC Garbage Compactor Truck

# User's Manual



HUBEI CEEC TRUCKS CO., LIMITED

<http://www.ceetrucks.com/>

Email: [info@ceetrucks.com](mailto:info@ceetrucks.com) [tom@ceetrucks.com](mailto:tom@ceetrucks.com)

# ISUZU HIGH-PERFORMANCE COMPACTOR MASTER



## CEEC TRUCKS **OWNER'S MANUAL**

Whatsapp: +86 136 4729 9000  
+86 159 7192 0800

**Dear Customer:**

The purchase of a new compactor truck is the easy part of the compacting business. The hard part is maintaining your truck. In order to do this, you need to do the following:

- Keep your compactor clean. A regular pressure washing improves your business image. A clean truck and compactor show clients that you respect your equipment and will give them the impression that you will do the same for their city. It also prevents breakdowns later. If necessary, paint your compactor after three years.
- Keep maintenance records and follow recommended maintenance timelines. Your compactor will not last forever. To preserve its value in the event you may want to trade it in for a new one, take care of it and keep all records.
- Know your compactor. You must know what your compactor can press and what it cannot. Don't try to take on a job that your compactor is not designed for. This damages your compactor body beyond retrieve.
- When your compactor is showing signs of fatigue, start plan for a new one. Call our sales department for details.
- Remember that maintenance is the key to success.



**CEEC TRUCKS**

- **CONTENTS**

Whatsapp: +86 136 4729 9000  
+86 159 7192 0800

- **SECTION I Daily Driver Check List**
- **SECTION II Quick Start Guide for Compactor Truck**
- **SECTION III Maintenance and Repair Instructions**
- **SECTION IV Common Failure and Troubleshooting**
- **SECTION V Equipment Description**

## CAUTION:

- Use diesel fuel only. Do not use gasoline or any other non-diesel fuel.
- Strictly prohibit people standing down the compactor when it is working.
- Must support security ejector when long time using.

## WARNING:

- Do not do two operation behaviors at the same time; all the operations should be carried out step by step.
- Keep no one stand down the compactor when it is compressing, especially at night.
- Hydraulic switch are Master switch, only start the hydraulic switch can achieve all functions.
- Main engine temperature over 100 degrees, should be immediately stopped for rest.
- Hydraulic tank oil temperature exceeds 70 degrees, should immediately stop for rest.
- Fan speed meter (*Auxiliary engine if needed*) speed should be maintained at almost 1800 RPM.
- Every week the spieled should add lubricant to keep they work smoothly and efficiently.

## SECTION I Daily Driver Check List

In order to prevent problems in daily operation, and to assure complete safety and satisfaction, it is necessary to always be aware of the condition of compactor truck. The daily inspection items listed in this section should be checked by you, the driver, every day before using your truck.

Prior to the daily inspection, make sure of the following items:

- 1, Is the truck on a level surface? (For safe, proper inspection)
- 2, Is the key "OFF"?
- 3, Is the parking brake applied properly?
- 4, Is the transmission gear shift lever in NEUTRAL?
- 5, Is the main control box work properly.

### Check Items

#### 1, Check outside the vehicle

- Is engine oil level normal?
- Is cooling water level normal?
- Is brake fluid level normal?
- Drain sediment oil from the air reservoir.

#### 2, Check after starting engine

- Is air pressure normal? Is it rising normally?
- Does the fuel tank have sufficient fuel?
- Does meters and gauges operate properly?
- Is the brake pedal free play normal?
- Depress the brake pedal, then release it. Is the exhaust noise normal?
- Is the clutch pedal free play normal?
- Is the steering wheel free play normal?
- Is operation of the lights and indicators normal?
- Is exhaust gas emission normal?
- Are oil, fuel or water leaks present?

#### 3, Compressing work

- Main engine acceleration should be smooth
- Main engine before into the normal tasks or flameout should idling 2 to 3 minutes,
- All water in the sink should be let out after working, which to keep sink normal.
- Normal working hours, forbidden any action.
- The hopper should be down every time loading garbage.
- Keep two rear control box to AUTO when choose automatic compress.
- Keep at least one rear control box to MANUAL when choose manual compress.

# SECTION II Quick Start Guide for Compactor Truck

## 1,1 Ready to work

(If idle for a long time, please keep the truck engine run for a few minutes. Also, should ensure fuel tank and water tank are enough. )

### Step 1

Thoroughly check the compactor to make sure working environment is good. Then start the truck engine. Press the Clutch Pedal, meanwhile press the Accelerator Handle Cable to Working Position. Then the PTO get power from truck engine, the garbage compactor superstructure can start working.

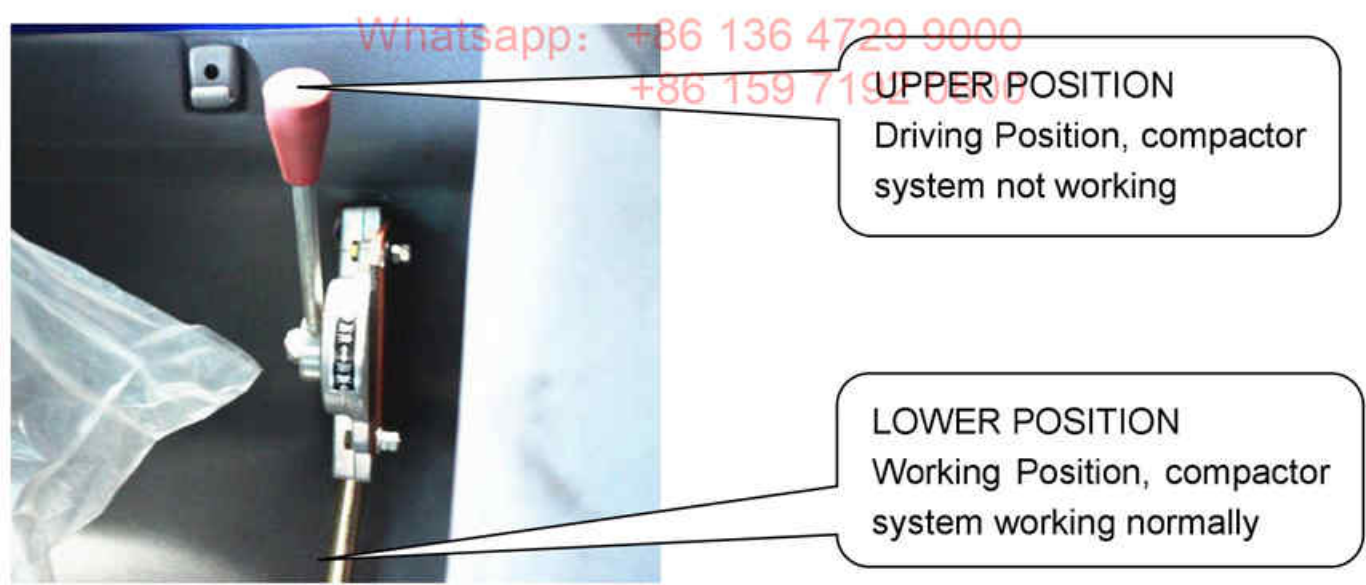

**NOTE:** Please keep the Accelerator handle Cable at Driving Position while driving the truck!  
Please does not operating the garbage compactor system while driving the truck!

## Step 2

Starting the **POWER SWITCH** in the cabin main control box, turn the button to **LOAD**, then **POWER INDICATOR** is ON, **LOAD INDICATOR** is ON, the garbage compactor superstructure can start loading jobs.

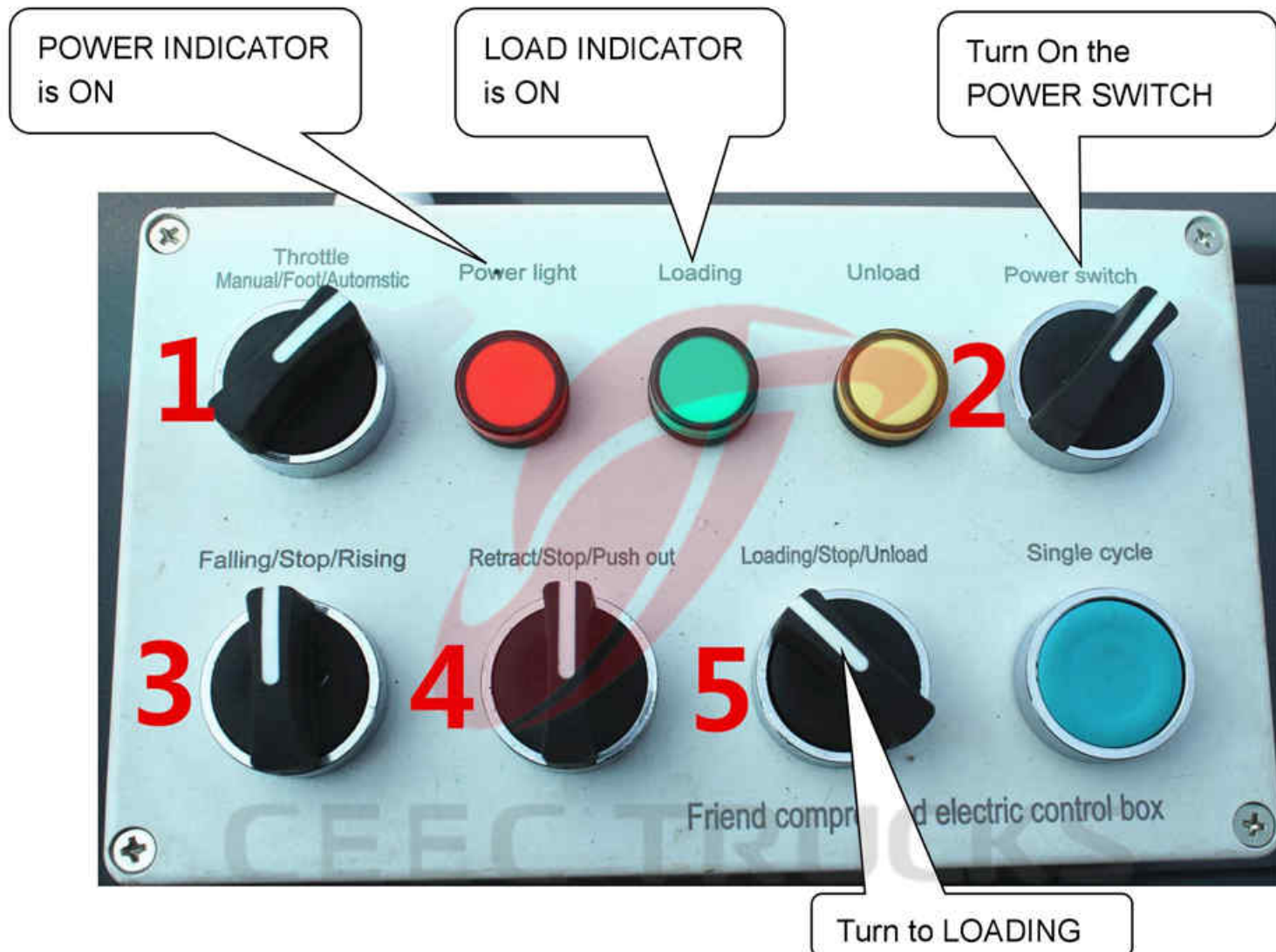

- Whatsapp: +86 136 4729 9000  
+86 159 7192 0800
- Switch 1: **Throttle** Manual / Foot / Automatic (Automatic is recommended)
  - Switch 2: **Power Switch** (Whole truck electric box working)
  - Switch 3: **Tailgate** Falling / Stop / Rising (Control Tailgate working)
  - Switch 4: **Push Plate** Retract / Stop / Push out (Control Push Plate working)
  - Switch 5: Working Model Loading / Stop / Unloading

## Step 3

Make sure the working environment is safe.

**NOTE:** No staying under Tail Gate

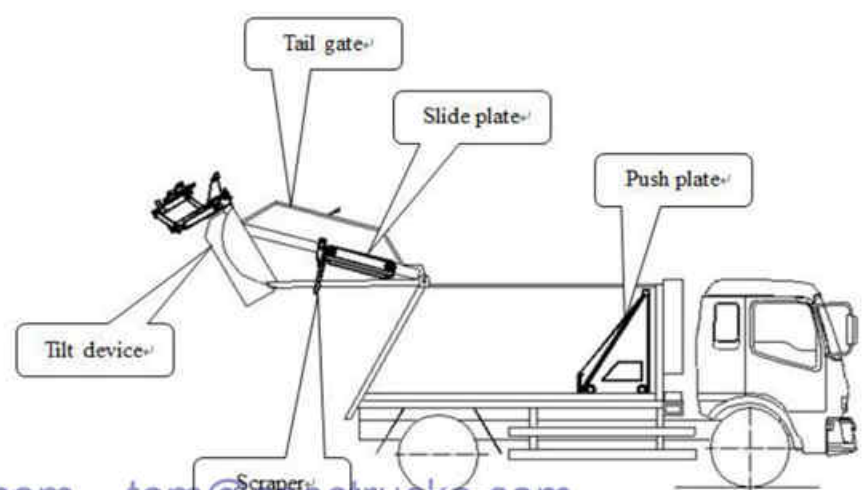

Step 4

Operation the rear control box to work.

Garbage Compactor Tank Introduction:

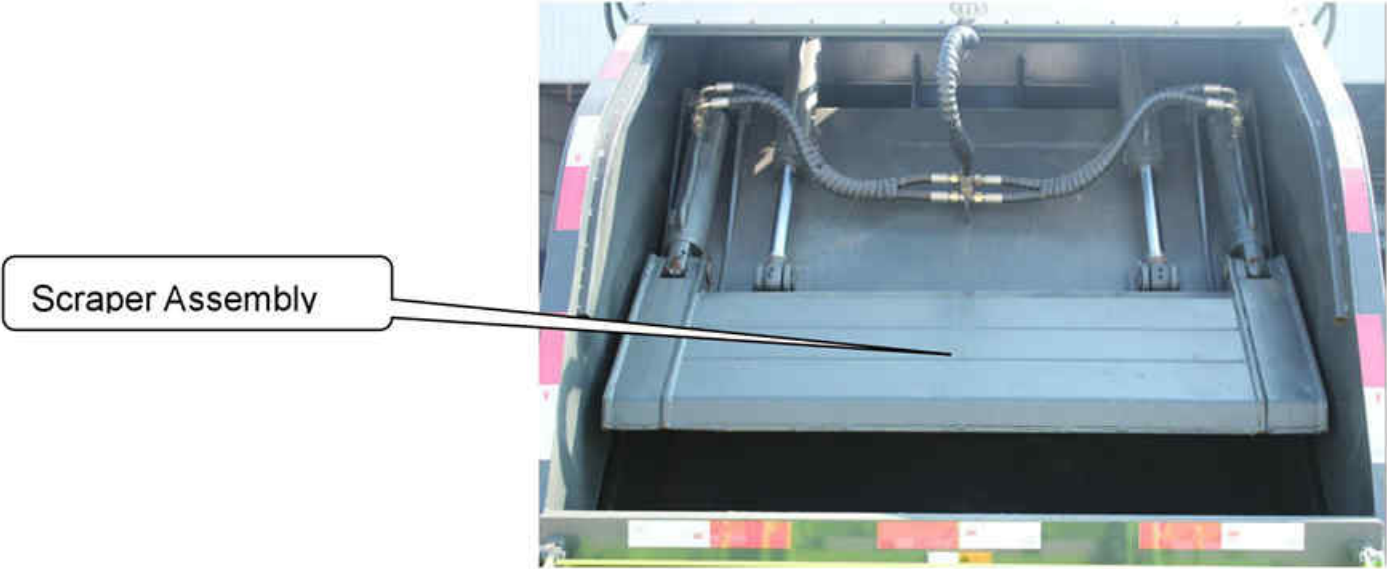



Push Plate Assembly  
(Internal of Compactor  
Tanker Body)



Tilt Device Assembly  
(1. Tilting double 240L garbage  
bin same time  
(2. Tilting 1100L garbage bin



# CEEC TRUCKS

Whatsapp: +86 136 4729 9000  
+86 159 7192 0800



Main Control Box



Rear Control Box

## Rear control box operate instruction.

Automatic operating system & Manual operating system available to you!

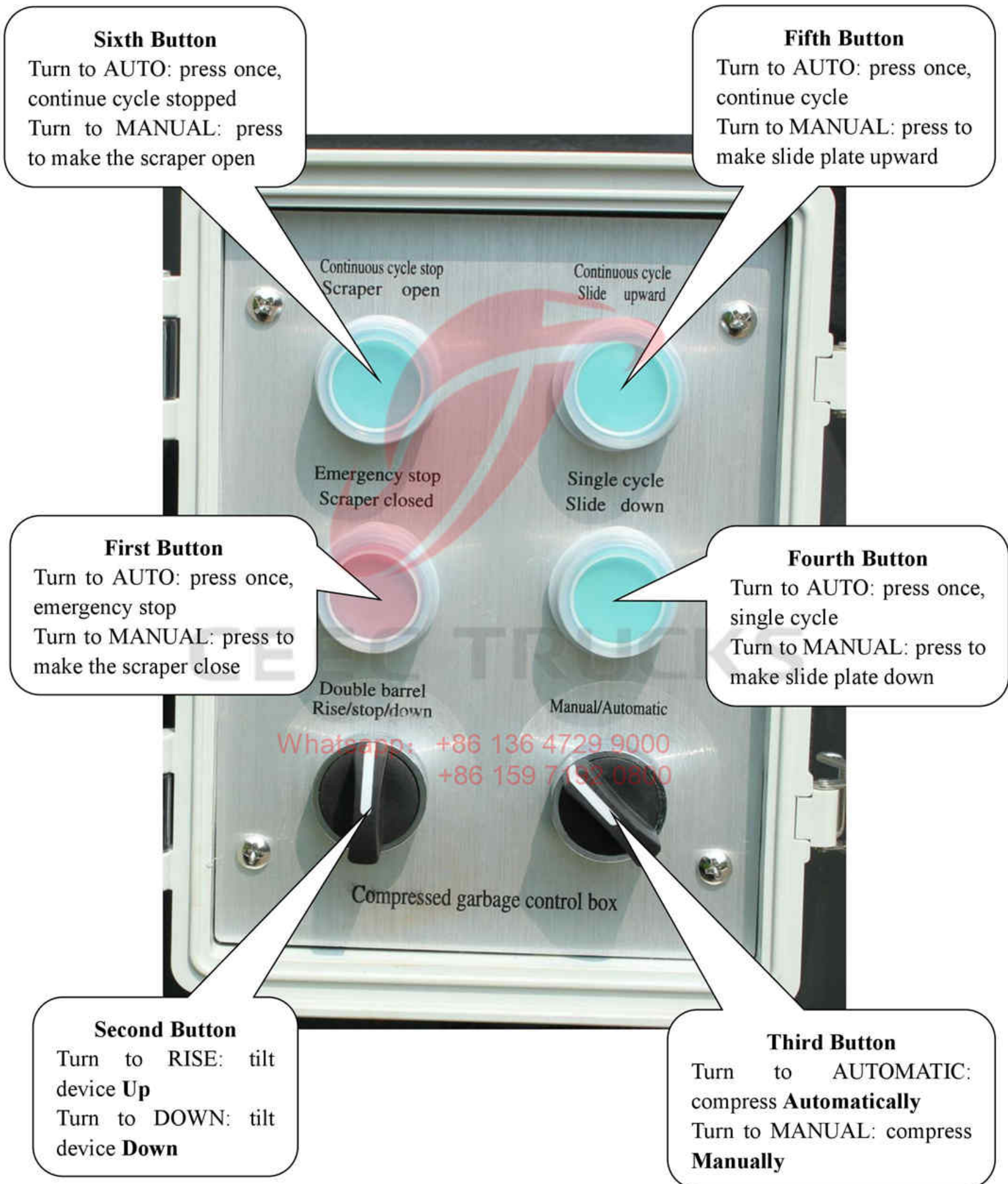

## Automatic operating system

### Third Button Turn to AUTOMATIC (main control box & rear control boxes)

#### Step 4.1.1

Second button turn to DOWN, the **tilt device** down, collecting the garbage from 240L garbage bins or 1100L garbage bins;

Then turn to RISE, the **tilt device** up, the garbage down to the Tail Gate stuffer.

Turn to DOWN again to make tilt device reposition before the scraper working.

(How does this model garbage compactor truck tilting device working?)



Tilt Device DOWN



Tile Device UP

#### Step 4.1.2

Whatsapp: +86 136 4729 9000

+86 159 7192 0800

Press the Fourth button, compression single cycle (**little garbage at Stuffer**)

Press the Fifth button, compression continue cycle (**much garbage at Stuffer**)

#### Step 4.1.3

Press the Sixth button, when continue cycle compression finished.

**NOTE:** Press the First button when there is an emergency!

#### Step 4.1.4

Make the **tilt device** STOP, the truck is ready for next compression work.

## Manual operating system

**Third button turn to MANUAL (main control box & rear control box)**

### Step 4.2.1

Second button turn to DOWN, the **tilt device down**, collecting the garbage from 240L garbage bins or 1100L garbage bins;

Then turn to RISE, the **tilt device up**, the garbage down to the Tail Gate stuffer.

**Turn to DOWN again make tilt device reposition before the scraper working.**

### Step 4.2.2

Press the fourth button to make **slide plate down**.



Whatsapp: +86 136 4729 9000  
+86 159 7192 0800

### Step 4.2.3

Press the First button to make the **scraper closed** to collect garbage.

### Step 4.2.4

Press the Fifth button to make the **slide plate upward**

### Step 4.2.5

Press the Sixth button to make the **scraper open**

### Step 4.2.6

Operate once again to collect and compress more garbage.

(NOTE: tilt device should be **Stop** every time before the scraper working)



Tilt device should be the level as shown

### Step 5

**NOTE: Only suggest to use MANUAL JOYSTICK when maintenance or emergency!**

(Operation Joysticks with English version plate for operating guidance)

Control the **manual joystick** to work.

Joystick1: Push Plate  
Control the Push Plate  
**Out & In**

Joystick4: Lifting  
Control the tail gate **Up & Down**

Whatsapp: +86 136 4729 9000  
+86 159 7192 0800

Joystick5: Rolling Over  
Control the Tilting Device  
**Rise & Down**

Joystick2: Sliding Plate  
Control the slide plate **Down & Up**

Joystick3: Scraper  
Control the scraper **Off & On**

## 1,2 Dumping the garbage

**Step 1** Make sure **no staying under tail gate**.  
(Please be sure for every compression work)

**Step 2** Turn the main control box to **UNLOAD**



**Step 3** Control (Switch3 or Joystick4) to make the **tail gate up**. Please reposition when tail gate rises completely.

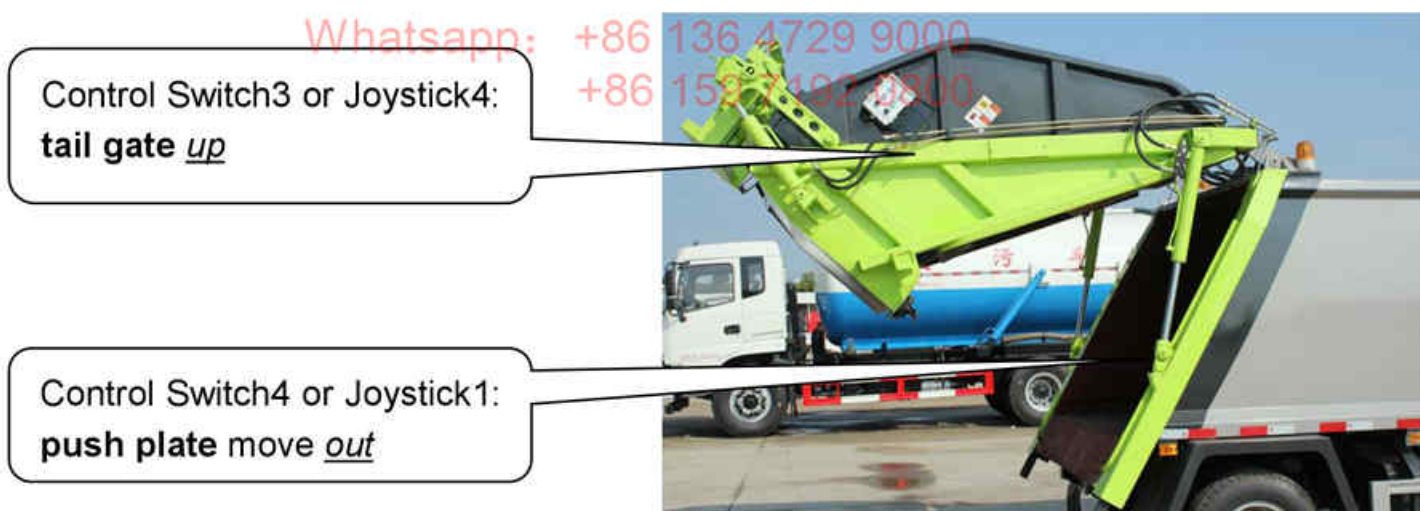

**Step 4** Control (Switch4 or Joystick1) to make the **push plate move out**.

**Step 5** Wait until all garbage discharged

**Step 6** Control (Switch4 or Joystick1) to make the **push plate** move in until reposition.

**Step 7** Control (Switch3 or Joystick4) to make the **tail gate** down. Please reposition all when **tail gate** down completely.

**Step 8** **Drain out** all the waste water produced by compressing work.



Whatsapp: +86 136 4729 9000  
+86 159 7192 0800

## 1,3 Cleaning

The engine must **flameout** when arrive at cleaning field.

**Step 1** Cleaning vehicle exterior.

**Step 2** Control (Switch3 or Joystick4) to make the **tail gate** up. Then cleaning the inside

body.

**Step 3** Cleaning the **tail gate device** internal.

**Step 4** Add some lubrication on spindle to keep compactor work safety and smooth.

Garbage Compactor Truck Hydraulic Drawing:

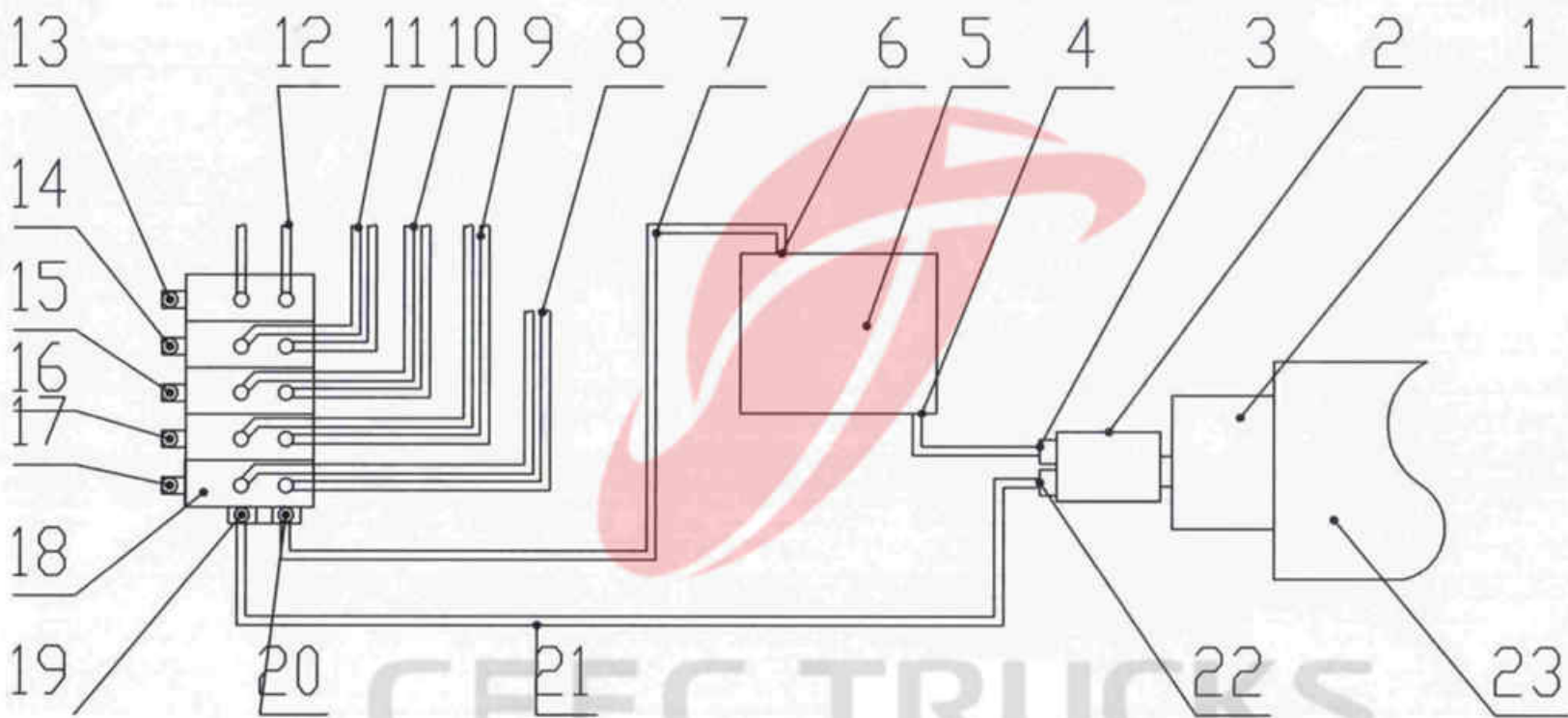

Whatsapp: +86 136 4729 9000

+86 159 7192 0800

- |                                  |                             |                           |                                   |                    |
|----------------------------------|-----------------------------|---------------------------|-----------------------------------|--------------------|
| 1、PTO                            | 8、Push Plate Oil Cylinder   | 13、Joystick 5 for Item 12 | 18、Multi-way Valve                | 23、Chassis Gearbox |
| 2、Oil Pump                       | 9、Slide Plate Oil Cylinder  | 14、Joystick 4 for Item 11 | 19、Oil Inlet for Multi-way Valve  |                    |
| 3、Inlet Pipe for Oil Pump        | 10、Scraper Oil Cylinder     | 15、Joystick 3 for Item 10 | 20、Oil Outlet for Multi-way Valve |                    |
| 4、Outlet pipe for Oil Tank       | 11、Tail Gate Oil Cylinder   | 16、Joystick 2 for Item 9  | 21、Oil Pipeline                   |                    |
| 5、Hydraulic Oil Tank             | 12、Tilt Device Oil Cylinder | 17、Joystick 1 for Item 8  | 22、Oil Inlet for Oil Pump         |                    |
| 6、Inlet Pipe for Multi-way Valve |                             |                           |                                   |                    |
| 7、Oil Pipeline                   |                             |                           |                                   |                    |

Hydraulic Oil change suggestion: **YWZ-80T hydraulic oil or standard hydraulic oil**

**For First Time:** After 150-hour working, please change the hydraulic oil;

**For Second Time:** After half year working, please change the hydraulic oil;

**Form Third Time:** After every year working, please remember to change the hydraulic oil.



# SECTION III Maintenance and Repair Instructions

## Maintenance and Repair Instructions

The routine maintenance requirements and procedures for each subsystem of the compactor are described.

### Every day

#### 1、 Before maintenance work, the following things should be done firstly:

- a、 Turn off the PTO(power take-off) and speed-up switch, turn the manual joysticks to middle level.
- b、 Flameout the engine, take the key and put it into your pocket or other place to make sure it's safe.
- c、 Use the parking brake.
- d、 Put a sign wrote "under maintenance, please do not start" on the steering wheel.
- e、 Put chock under the wheels to make truck stability.

2、 Cleaning vehicle exterior, the inside and outside of the tilt device, the oil tank and pipe, all these daily working has purpose to prevent rust and to keep compactor ready for work anytime.

Whatsapp: +86 136 4729 9000  
+86 159 7192 0800

3、 Carefully examine the hydraulic system, including whether hydraulic oil at normal level, whether the hydraulic pipeline leak oil or not, which can protect the compactor truck and always keep the compactor ready to work anytime.

4、 Carefully check whether the electric system work normal or not, including the tail lights, the work indicating lamp etc.

5、 Carefully clean the compress lock at the rear of the truck. To keep compression work efficiently.

6、 Carefully check the entire compactor to inspect whether any warning signs and operating instruction sign fell off. Catch up on them when necessary.

7、 Lubricate the whole pathway of the compressed garbage truck every day.

8、 Carefully clean the **push plate** and surrounding of the oil tank.

### Every week

1、 Carefully inject butter or other lubrication to the spindles of the compactor, places are as below pictures:

- a、 Lubricate the spindles of the tail gate
- b、 Lubricate the cover of pivots of the scraper
- c、 Lubricate the oil cylinder bearing of the scraper
- d、 Lubricate the pathway of the slide plate
- e、 Lubricate the all the connecting rod
- f、 Lubricate the chassis by following the maintenance manual



2、 Carefully exam the compactor to check out whether any connection place need to fasten again.

## Every month

- 1、 Carefully exam all the pipes, find out whether there is any leakage. If there are, please exchange it immediately.
- 2、 Carefully exam the compression cylinder and the scraper oil cylinder piston rod, find out whether they are all working normally.
- 3、 Carefully exam the push plate oil cylinder, find out whether it work normally.
- 4、 Carefully lubricate axles of the push plate to make it work smoothly and efficiently.
- 5、 Carefully lubricate the sideways of the push plate to make it work normally.

## Every 6 month

- 1、 Carefully cleaning the air filter.
- 2、 Carefully cleaning the oil suction filter.
- 3、 Carefully replace the oil filter cartridge
- 4、 Carefully exam the entire body of the truck to find out if anything need improved. Such as any place rusting; is the framework still work normally etc.

Whatsapp: +86 136 4729 9000  
+86 159 7192 0800

## Every 2 Year

- 1、 Cycle maintenance as mentioned above.
- 2、 Carefully clean fuel tank, replace the hydraulic oil.

## Maintenance of the hydraulic system

### 1、Hydraulic oil tank

- a、 Fine filter of oil return pipe: First exchange happened after 50 hours use, then every 250hours. When there is something wrong with the main parts of the hydraulic system also should change it.
- b、 Respirator: Keep the respirator clean, non-stop and correctly installed to make the air can goes inside the oil tank freely. Exchange the respirator every 6 month. (the exchange time should be short when working at dirty environment for a long time.)
- c、 Hydraulic oil: First exchange happened after 150 hours use,  
Second exchange happened after 6 month use,  
Then every 12 month use.

**NOTE: YWZ-80T hydraulic oil or standard hydraulic oil;**

- d、 Oil outlet strainer: Should be cleaned every time exchange the oil. Replace it when necessary.

### 2、 Oil cylinder

- a、 Carefully exam the oil cylinder to find out whether there is leakage and noise or not every week. **Whatsapp: +86 136 4729 9000**  
**+86 159 7192 0800**
- b、 Carefully check the oil tank, repair when there are scar on piston rod, repair all the scars in time to avoid any danger.

## SECTION IV Common Failure and Troubleshooting

Failure	Cause	Solution
Oil leakage happened on oil cylinder piston rod	<ol style="list-style-type: none"> <li>1、 The damage of the sealing ring</li> <li>2、 There are scars on the surface of the piston rod</li> </ol>	<ol style="list-style-type: none"> <li>1、 Carefully exam the guide sleeve and replace the sealing ring</li> <li>2、 Replace the parts.</li> </ol>
Piston rod move slowly	<ol style="list-style-type: none"> <li>1、 Some air mixed in the hydraulic cylinder or in the hydraulic oil</li> <li>2、 There are no hydraulic oil in the tank or oil level is too low to work normally.</li> <li>3、 Viscosity of hydraulic oil failing standard</li> <li>4、 Stoppage of the oil inlet/outlet strainer</li> <li>5、 Stoppage or limiting of the hydraulic oil in system</li> <li>6、 Leakage of the oil suction pipe</li> <li>7、 Abrasion of the oil pump</li> <li>8、 Abrasion of some parts</li> <li>9、 Adjustment of the parts are not proper.</li> <li>10、 Pressure valve is too dirty</li> <li>11、 Overload of the system work</li> <li>12、 Improper oil pipe connection</li> <li>13、 Oil pump not work</li> </ol>	<ol style="list-style-type: none"> <li>1、 Eliminate all the air</li> <li>2、 Inject some hydraulic oil and carefully check the system.</li> <li>3、 Replace hydraulic oil to recommended ones.</li> <li>4、 Carefully clean or replace it, and find out the polluted reason</li> <li>5、 Carefully check the oil pipes and clean them.</li> <li>6、 Repair or replace it</li> <li>7、 Repair or replace it</li> <li>8、 Carefully check the pump, valve and oil cylinder, find the abrasion part and repair or replace it.</li> <li>9、 Refer to the technical manual to adjust properly</li> <li>10、 Carefully clean it</li> <li>11、 Refer to the technical manual to load properly.</li> <li>12、 Reconnect the oil pipe properly</li> <li>13、 Carefully check the PTO</li> </ol>

	<p>14、 The hydraulic oil temperature is too low</p> <p>15、 The engine's revolving speed is not enough</p>	<p>14、 The viscosity is too high and should be adjust oil temperature to working level</p> <p>15、 Adjust to proper level</p>
Hydraulic cylinder pushing is powerless	<p>1、 Damage of the piston sealing</p> <p>2、 System pressures is too low (the overflow valve became imbalance)</p> <p>3、 Damage of the oil pump, System pressures is too low</p> <p>4、 Shortage of the hydraulic oil</p> <p>5、 Stoppage of the oil filter</p>	<p>1、 Carefully exam and replace the sealing element</p> <p>2、 Carefully exam and adjust the pressure of the overflow valve</p> <p>3、 Carefully exam and replace the oil pump</p> <p>4、 Carefully exam and fulfill the hydraulic oil</p> <p>5、 Carefully exam and replace the filter element</p>
Leakage of the oil pump	<p>1、 Damage of the sealing filter</p> <p>2、 The oil pipes are not sealed as required</p>	<p>1、 Carefully exam and replace the sealing ring</p> <p>2.1、 Carefully exam, tighten the joint</p> <p>2.2、 Replace the joint or add some sealant to seal the joint</p>
Blister exist in the hydraulic oil	<p>1、 Oil level in the tank is too low</p> <p>2、 There is water in the hydraulic oil</p> <p>3、 Leakage of the pipe between the oil tank and the pump</p> <p>4、 Hydraulic hose is kinked or squished, and limit the flow of the oil</p> <p>5、 Have not choose the right hydraulic oil</p> <p>6、 Abrasion of the sealing parts in oil pump axle</p>	<p>1、 Adjust the oil to required level. Carefully exam the leakage of the system.</p> <p>2、 Exchange new hydraulic oil</p> <p>3、 Fasten the joint or exchange suction pipe</p> <p>4、 Replace the oil pipe</p> <p>5、 Exchange to the recommend oil</p> <p>6、 Carefully clean or replace it.</p>

<p>Oil pump is too noise while working</p>	<ol style="list-style-type: none"> <li>1、 The hydraulic oil viscosity is too high</li> <li>2、 Speed of the oil pump is too high</li> <li>3、 Suction pipe is blocked or extrusion</li> <li>4、 The oil tank's respirator is blocked</li> <li>5、 Primary oil filter is blocked</li> <li>6、 Parts sticking to each other</li> <li>7、 There are air in the hydraulic oil</li> <li>8、 Hydraulic oil level is too low</li> <li>9、 Parts of the oil pump is abrasion</li> </ol>	<ol style="list-style-type: none"> <li>1、 Change low viscosity oil</li> <li>2、 Adjust the oil pump's speed to required level.</li> <li>3、 Cleaning or exchange the suction pipe</li> <li>4、 Open the respirator , Carefully wash to clean it.</li> <li>5、 Cleaning the filter screen</li> <li>6、 Carefully repair the sticking parts, cleaning all of them, and replace when necessary</li> <li>7、 Carefully check the system, replace the suction pipe and sealing parts.</li> <li>8、 Adjust to proper level</li> <li>9、 Repair the oil pump and find out the reason</li> </ol>
<p>Leakage of oil cylinder</p>	<ol style="list-style-type: none"> <li>1、 Damage of the cylinder</li> <li>2、 Damage of the parts of piston valve</li> <li>3、 Parts of the oil cylinder is loose</li> <li>4、 Damage of the piston rod</li> </ol>	<ol style="list-style-type: none"> <li>1、 Replace the cylinder and find out why it damaged</li> <li>2、 repair or replace the piston valve, find out the reason</li> <li>3、 Fasten the parts until no leakage</li> <li>4、 Carefully exam, exchange it when necessary</li> </ol>
<p>Hydraulic oil temperature is too high</p>	<ol style="list-style-type: none"> <li>1、 Use the control valve for a long time</li> <li>2、 Hydraulic oil is not proper</li> <li>3、 The revolving speed is high</li> <li>4、 The inside leakage</li> </ol>	<ol style="list-style-type: none"> <li>1、 The manual joystick should reposition when not use</li> <li>2、 Exchange to proper oil</li> <li>3、 Adjust to proper level</li> <li>4、 Carefully check the pump, valve and oil cylinder to find out reason, then repair it.</li> </ol>