

# ISUZU



**CEEC TRUCKS INDUSTRY CO., LIMITED**

Email: [info@cectrucks.com](mailto:info@cectrucks.com) [tom@cectrucks.com](mailto:tom@cectrucks.com)

# Fuel Tanker Truck



CEEC TRUCKS

Whatsapp: +86 136 4729 9000  
+86 150 7193 0500  
**OWNER'S MANUAL**

# Preface

Thank you for purchasing CEEC TRUCKS products. For better using your ISUZU Fuel Tanker Truck, get the best operating performance, we strongly suggest that before the operation process you could read this manual instructions carefully, and to manipulate the program handily.

The manual detailed describes the performance of fuel tanker truck, structure, usage, precautions and maintenance of such knowledge. While showing details of the truck, both pictures and description will together help you get better understanding of how to use truck. Before the operation, the skilled operator should carefully read the contents of the manual.

After master the truck performance characteristics, methods of operation and precautions, then could start to operate this refueling tanker truck. In order to ensure the staff turnover after the operation, and properly use of the truck. This manual book must be properly kept, shall not be lost and damage.



CEE C TRUCKS ----CEE C TRUCKS

Whatsapp: +86 136 4729 9000  
+86 159 7192 0800



# Contents

Chapter 1. General Description.....	5
Chapter 2, Main Technical Data.....	6
Chapter 3, Fuel Pump & Fuel Dispenser .....	8
Chapter 4, CENSTAR Fuel Dispenser .....	10
Chapter 5, Fuel Tanker Truck Structure Components .....	12
i ,Fuel Tanker Structure Components .....	12
ii ,Fuel Pipeline Structure Components .....	14
Chapter 6, Fuel Tanker Truck Working Principles .....	16
i ,How are the fuel trucks working?.....	16
ii ,What is the main component for truck?.....	16
iii, How to operate fuel tanker trucks?. (Very Important).....	17
IV, How to operate CENSTAR Fuel Dispenser?.....	23
Chapter 7, Others for Attention .....	25
i ,Precautions for Use .....	25
ii ,Maintenance .....	26
iii, Spare Parts List .....	26



## Chapter 1. General Description

*CEEC TRUCKS Fuel Tanker Truck based on type II ISUZU Left Hand Drive chassis, Fuel tanker capacity could up to 5,000liters, which also installed with famous Chinese brand CENSTAR Fuel Dispenser, mainly used for Fuel storage, transportation and refueling, and the working aerial can be city street, factory, desert areas and other areas of need.*

*The vehicle designed to fully rely on the advantages of the original of ISUZU brand chassis, fully consider the product's convenience and reliability, also the chassis ISUZU technology features. The fuel tanker material is international standard carbon steel, both internal and external with anti-rust painting, which can effective to avoid rusting. As for tank capacity, this is strictly 5CBM and safety enough to transport & refueling oil based on customer requirement.*

*The ISUZU 4x2 Fuel Tanker Truck equipped with CENSTAR refueling machine, rear climbing ladder, Euro standard Manhole, top & side & rear guard plate and safety fuel inlet & outlet valves to help better use of the trucks. Cab for the single-row Comfortable seat, nice driving feeling. Therefore, the vehicle is an ideal Fuel Tanker Truck mainly for oil transportation & refueling function.*



**(Preview for your ISUZU Fuel Tanker Trucks)**



## Chapter 2, Main Technical Data

### Basic parameter:

Items		5CBM ISUZU Fuel Tanker Truck
S I Z E	Outer Dimension (L×W×H) (mm)	6600x2190x2350
	Wheelbase (mm)	3815
Kerb Weight (kg)		6000
G E A R	Gearbox brand	ISUZU MLD
	Model	6-shift gearbox
	Type	Manual
Cab capacity (includes driver)		2
E N G I N	Brand	ISUZU
	Model	4HK1-TC
	Type	Six cylinder inline, four stroke, water-cool, turbocharged Inter-cooling, diesel
	Rating Power (kW/HP)	140/190

Note: 1. The vehicle height includes Rear Climbing Ladder.

2. We keep the right to revise the parameters on the list above.

### Water Tanker basic parameter list

Items		Parameter	
Water tanker	Capacity (Liters)	5000	
	Material	Standard Carbon Steel	
	Painting	Internal	With anti-rust painting
		External	White painting
	Special Equipment	Refueling Machine	CENSTAR Brand, Equipped on side of tank
		Valves	Equipped on side of tank
		Climbing Ladder	Equipped at rear of tank
Safety Guard		Equipped on top of tank	
Fuel Pump	Model	80YHCB-60	
	Fuel Flow Rate (m <sup>3</sup> /h)	60	
	Working Pressure (MPa)	0.6	
	Revolving Speed (r/min)	970	
	Self-Suction Height (m)	7	
	Rated Power (kw)	11	

### Fuel Dispenser parameter list

Fuel Dispenser	Model	CENSTAR CS20D1110F	
	Accuracy:	±0.25%	
	Flow rate range:	5 to 50 liter per minute	
	Noise:	≤72dB(A)	
	Display:	Sales 0.00 to 9999999	
	Volume:	0.00 to 99999.99	
	Unit price :	0.00 to 99999	
	Electrical totalizer :	Decimal point position can be chosen	
		Volume 0 to 42949672.95L	
		Money 0 to 42949672.95V	
	Power supply:	DC10V to DC30V	
	Working temperature:	-25oC to +55 oC	
	Relative humidity:	30% to 90%	
Package size:	540*480*650mm		
More details for Water Pump showing as below			



# CEEC TRUCKS

Whatsapp: +86 136 4729 9000  
+86 159 7192 0800

## Chapter 3, Fuel Pump & Fuel Dispenser

### *Brief introduction of 80YHCB-60 fuel pump:*

*ISUZU fuel tanker truck use TOP Chinese brand Fuel Pump and pump model is 80YHCB-60. The pump is newly produced National Patent Products which based on many years' independent developing & production of arc gear pump. Also the pumps comply with national standards JB/T6434-92. Advanced features for the pump showing as below: Simple Structure, Smooth Operation, High Efficiency and Reliable Operation.*

*Below is overview for 80YHCB-60 model fuel pump:*

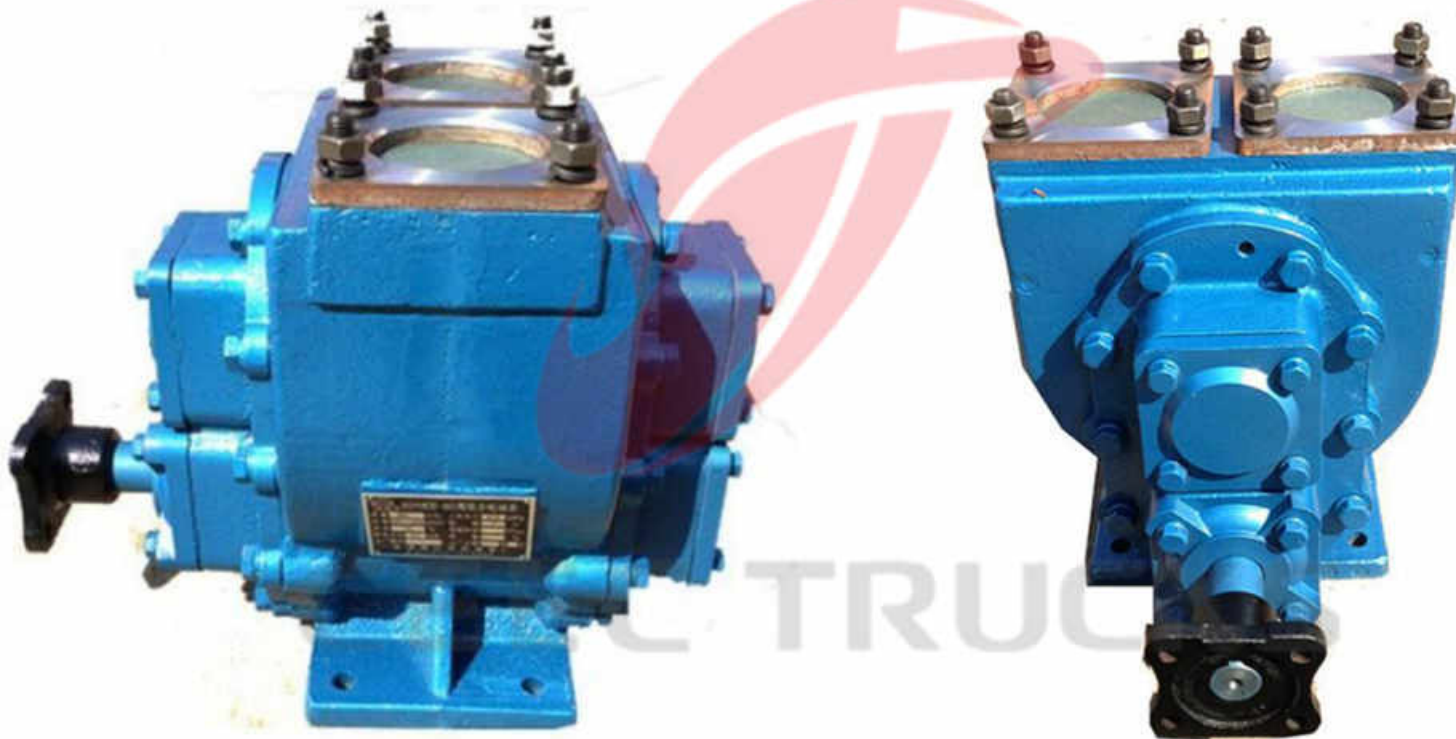

Whatsapp: +86 136 4729 9000  
+86 159 7192 0800

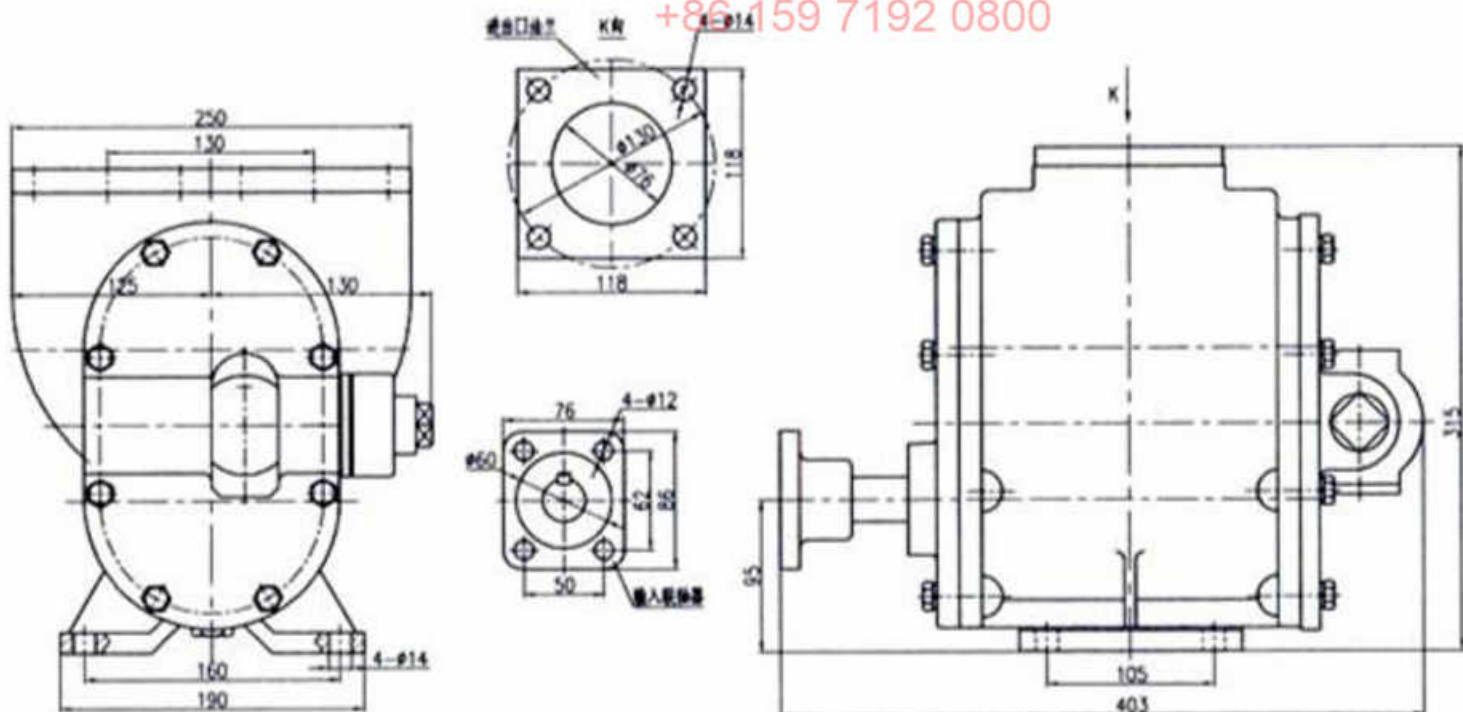



**How to Installation & Maintenance 80YHCB-60 fuel pump:**

Items	Notification	
1	Usage	<ol style="list-style-type: none"> <li>1. Installed on Fuel Tanker Truck</li> <li>2. Installed on Fuel Storage House</li> </ol>
2	What need to pay attention while installed on fuel tanker truck	<ol style="list-style-type: none"> <li>1. The pump get power from PTO</li> <li>2. The pump is installed in hanging bracket under chassis frame</li> <li>3. Pumping-In pipeline should match with pump hole, and max. suction height less than 7m</li> <li>4. On working condition, the pressure gauge less than 0.5MPa, and vacuum gauge less than -0.08MPa</li> </ol>
3	Before start working	<ol style="list-style-type: none"> <li>1. Test the shaft valve direction of rotation</li> <li>2. Test the Fittings and Flange sealing</li> <li>3. Test all valves</li> </ol>
4	Cleaning suggestion	<ol style="list-style-type: none"> <li>1. Washing the filter have a month, so to avoid any block</li> <li>2. Adjust the discharging pressure of safety valve</li> </ol>
5	Pump revolution speed suggestion	The pump revolution speed should be from LOW to HIGH, and speed up slowly. Not allowed any over revolution speed or any instability speed
6	Watching pressure gauge & vacuum gauge while pump working	<ol style="list-style-type: none"> <li>1. When pressure gauge higher, means the lifting is over height or the pumping-out pipeline is blocked</li> <li>2. When vacuum gauge high, means the suction is over distance or the pumping-in pipeline is blocked</li> </ol>
7	Maintenance for cold weather and not working	Discharging all storage inside pump, which can avoid frost crack
8	Maintenance for long-term use	Treated with anti-rust processing and keeping properly
9	Maintenance for bearings	Filling calcium grease every half year
10	Pipeline installation suggestion	The pipeline should be installed at proper height and position
11	Stop working suggestion	When stop the truck, firstly disconnect the PTO handle, secondly close the inlet & outlet valve of the fuel pump
12	Start working suggestion	When no medium inside the fuel pump, strictly forbidden starting

## Chapter 4, CENSTAR Fuel Dispenser

### Brief introduction of CS20D1110F Fuel Dispenser:

CENSTAR Fuel Dispenser can be installed on fuel tanker truck and mainly used for refueling all kinds of trucks. This ISUZU tanker truck equipped CS20D1110F model fuel dispenser, with detailed specification showing on chapter 2. Also the refueling machine complies with national standards GB/T9081-2008. Advanced features for the pump showing as below: Simple Structure, Smooth Operation, High Efficiency and Reliable Operation.

Below is overview for CS20D1110F model fuel dispenser:

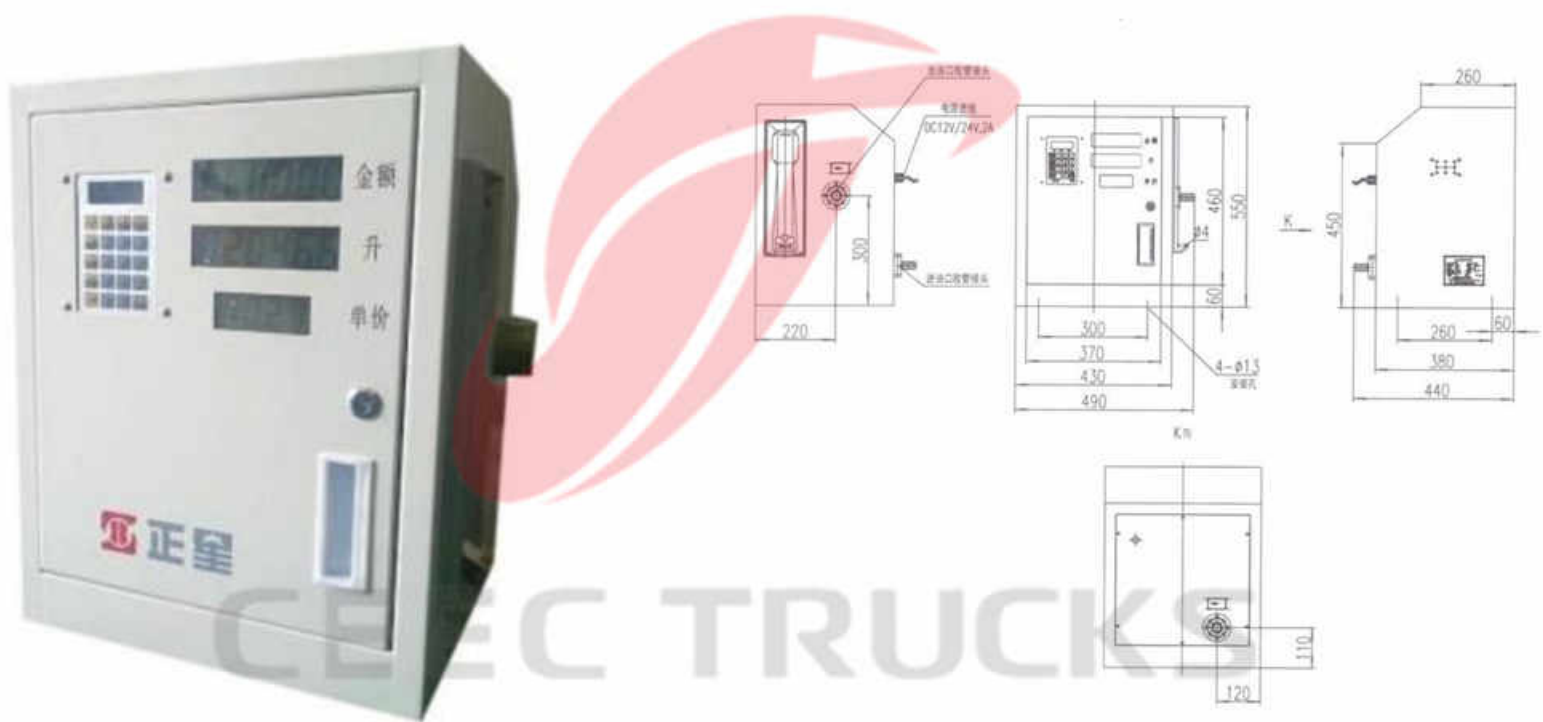

Whatsapp: +86 136 4729 9000  
+86 159 7192 0800

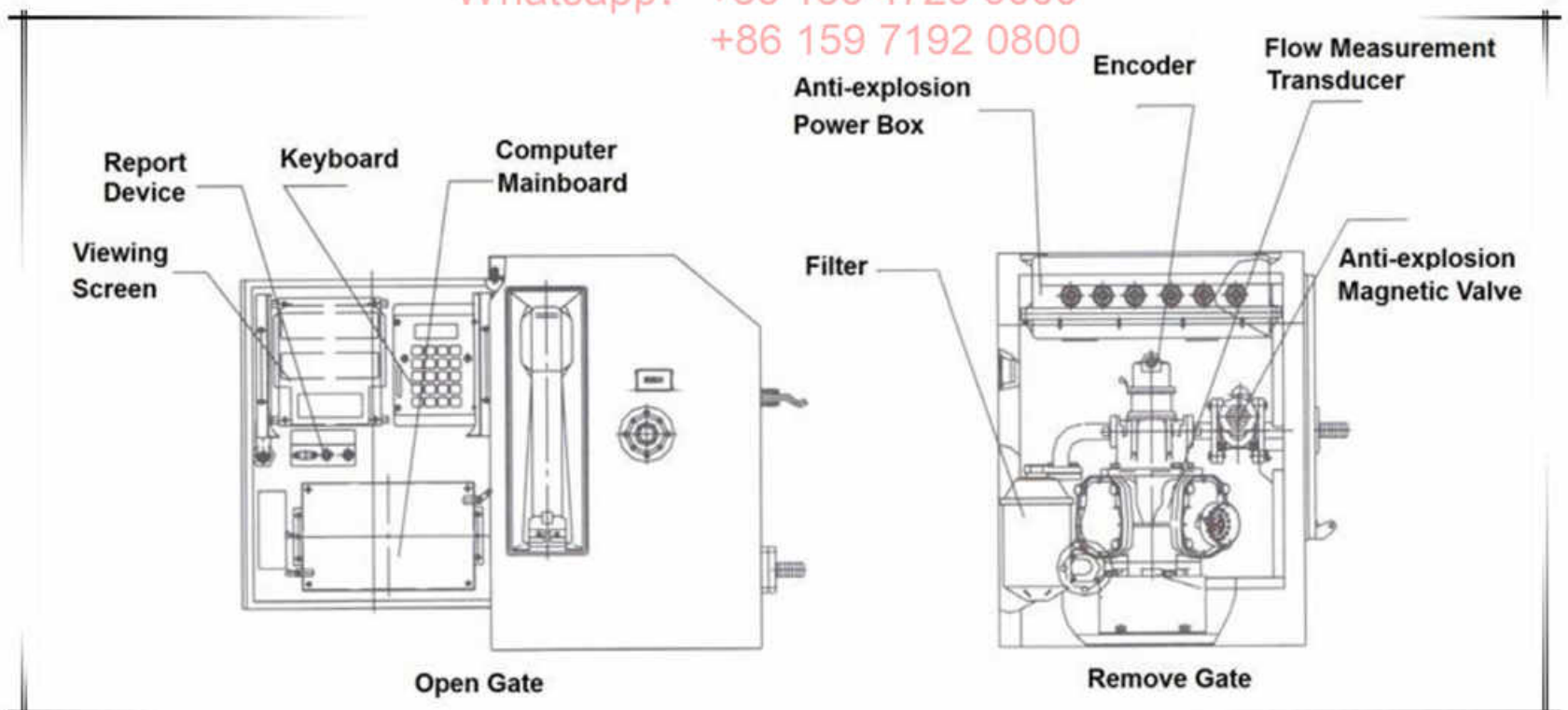



**How to Maintenance CS20D1110F fuel dispenser:**

Items	Notification	
Regular inspection & Maintenance	A Week	<p><b>Leakage:</b> Inspection of pipeline, Joint, Inlet &amp; Outlet valve</p> <p><b>Lead Sealing:</b> Inspection of the lead sealing</p> <p><b>Filters:</b> Inspection and see whether need to clean or change</p>
	As Required	<p><b>Refueling Machine Clean:</b> Cut off power and open the gate to clean. No gasoline and diesel is allowed to wash the appearance</p> <p><b>Flow Measurement Transducer:</b> Inspection of the accuracy</p> <p><b>Door Lock:</b> Inspection and replace</p>
	Half Year	<p><b>Refueling Gun:</b> Inspection of flexibility, add lubricant oil if not</p> <p><b>Pump:</b> Inspection of flow rate, maintenance if necessary</p> <p><b>Filters:</b> Inspection of dexterity</p>
FAQ	No normally Power On	<ol style="list-style-type: none"> <li>Carefully inspecting the power connection</li> <li>The machine has delay Power On function, which means the shutdown time between power on and off should more than 3 second.</li> </ol>
	Leakage on sealing or O-ring	<ol style="list-style-type: none"> <li>The Sealing or O-ring inflate or damaged, need to smears grease or replace</li> <li>Bolt loose, tightening the bolt</li> </ol>
	Non-working of LCK	<p>Normally the Hole of LCK pointing to Red light, then input parameter and turn right to have the Hole of LCK pointing to Green light, finally turn left to replacement. If not following the above operation step, the LCO will not work.</p>
	Flow rate is instability	<ol style="list-style-type: none"> <li>The fuel level is too low and too much air inhaled, solution is make level higher</li> <li>The Oil pipeline is blocked. Refueling gun and filter are not opened thoroughly. Please cleaning or replace them.</li> </ol>
	Measurement is not accurate	<ol style="list-style-type: none"> <li>Carefully check the leakage of fuel pump, pipeline and all joints</li> <li>Some impurity in the oil, which damages the Flow Measurement Transducer, please repair or replace.</li> <li>The O-ring is damaged, please replace it</li> <li>Distribution valve and bottom sealing plate is dirty, please cleaning all of them</li> </ol>

# Chapter 5, Fuel Tanker Truck Structure Components

## i ,Fuel Tanker Structure Components

Overview for ISUZU fuel tanker truck technical drawing:

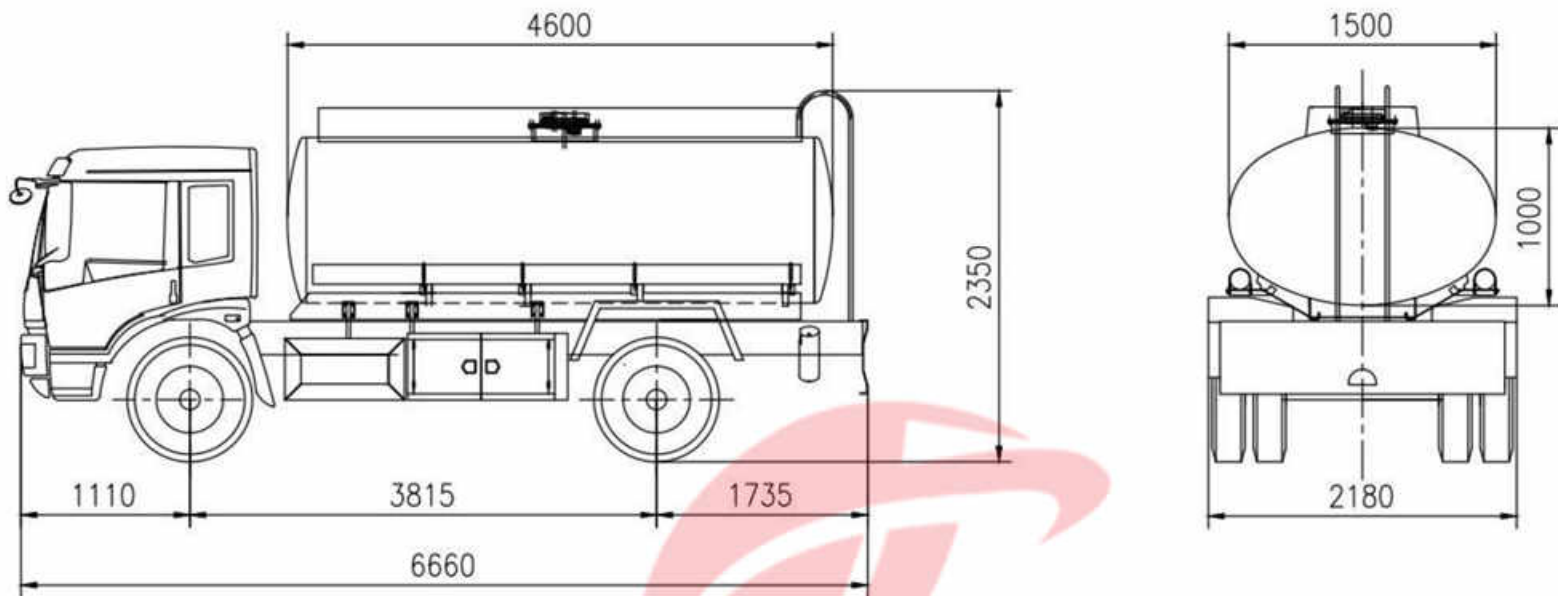

Above drawing show that there are safety-guards at two sides & rear; on driver side installed the Fuel Dispenser; on top of tank equipped one Euro standard Manhole, also aisle and handrail on two sides; at rear of tank equipped climbing ladder. The whole fuel tank is **oval shape**:

Top of the Tank: safety fence, manhole and Euro standard manhole cover

Euro standard manhole covers with Key (Top of tank)



Whatsapp: +86 136 4729 9000  
+86 159 7192 0800

Handrail (Top of tank)



Walkway (Top of tank)



Rear of the Tank: Climbing ladder with three level

Climbing ladder & Rotation warning lamp (Rear of tank)



Side of the Tank: Pipeline storage box & Fire-extinguisher storage box

Pipeline storage box & nearly 4 meter long pipeline (2 sets)



Fire-extinguisher storage box (Two sides) & 4kg powder fire-extinguisher (2 sets)



Whatsapp: +86 136 4729 9000  
+86 159 7192 0800

Driver's other side of the Tank: Tool box

Tool Box, which can storage all kinds of goods, and can be locked for safety.



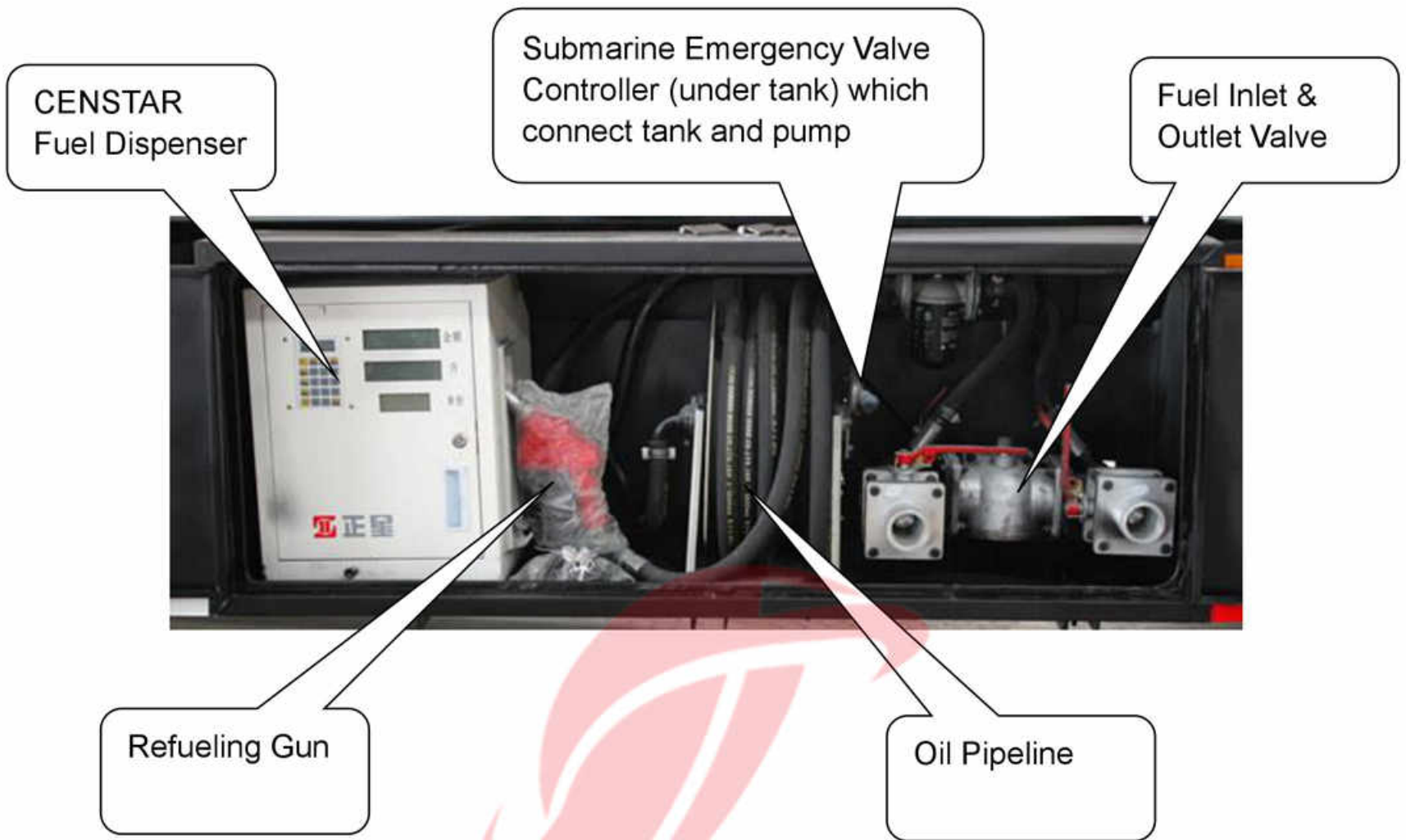

## ii, Fuel Pipeline Structure Components

Pipeline is to fuel truck what blood vessel is to human body! The fuel tanker trucks pipeline system is simple but very practical. One main pipeline connect with fuel tank and fuel pump, which means there are two ways to collection water: firstly is pumping fuel directly through Fuel pump; secondly is collection fuel from top Manhole.

Whatsapp: +86 136 4729 9000

At side of the truck which installed Fuel pump, also Fuel inlet & outlet valves (Pipeline system as below):

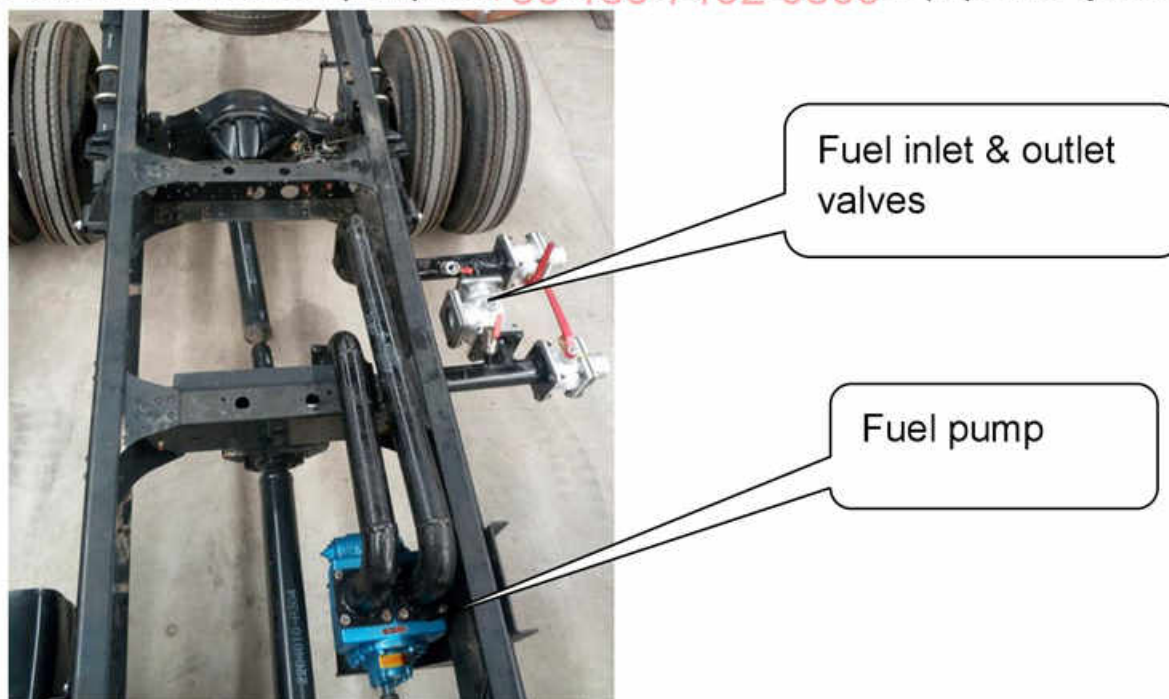



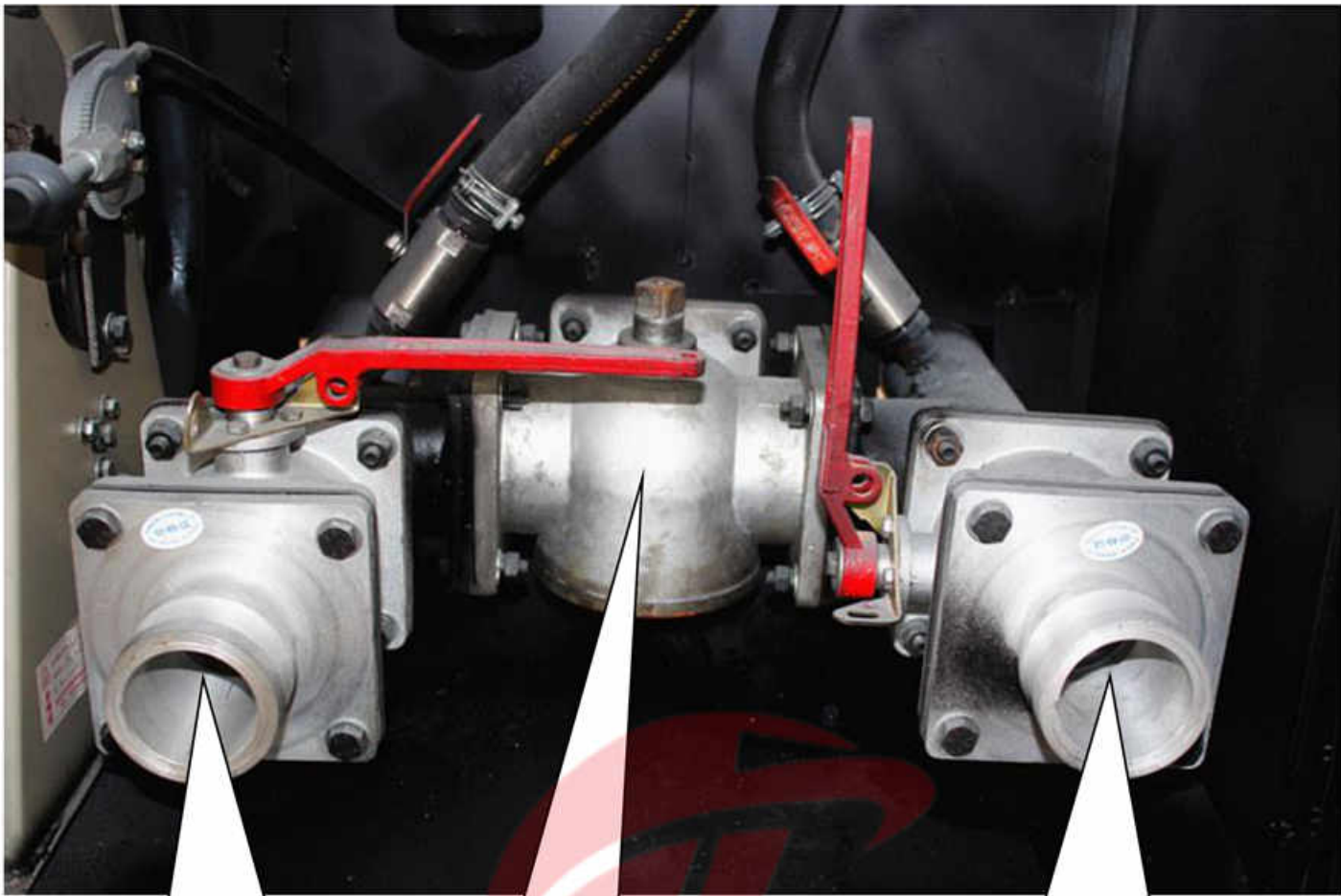

Double-Way Valve #1  
(Entrance)  
Pumping fuel into the tank

Three-Way Ball Valve  
Control fuel in & out of  
the tank

Double-Way Valve #2  
(Exit)  
Pumping fuel out of the tank

# CEEC TRUCKS

Whatsapp: +86 136 4729 9000  
+86 159 7192 0800

## Chapter 6, Fuel Tanker Truck Working Principles

The operator should fully understand Whole Structure and Working Principle for ISUZU Fuel Tanker Truck before any operation. Only trained person can operate this vehicle properly and to prevent unnecessary accidents and equipment damage.

### i ,How are the fuel trucks working?

The ISUZU Fuel Tanker Truck makes use of the special power take off (PTO) to get power from the engine, and then transfer the power to the Fuel Pump via drive axle so to rotate the pump. The fuel pump, pipelines, valves and joints consist of the pipeline system. Turn on/off valves through the regulated program, the pump can absorb fuel into the tank, also can pumping-out the fuel. As for the CENSTAR fuel dispenser, this can be used refueling all trucks through the special gun. And then come to all function.

### ii ,What is the main component for truck?

The fuel tanker truck is refitted based on the ISUZU 4x2 LHD chassis. The refit part includes fuel carrying assembly, actuator device, pipeline system, operation system and refueling machine.

- Fuel carrying assembly: A carbon steel container shaped ellipse, with anti-rust painting, which is used to store and transport oil.
- Actuator device: includes power take off, drive line, etc., which can pass the power from the chassis to the pump.
- Pipeline system helps come to all special functions.
- Operation system: helps come to all special functions' convert.
- Refueling machine: helps to refuel all kinds of trucks



iii, How to operate fuel tanker trucks?. **(Very Important)**

1, Refer to Chapter 5 and get more information about valves structure component.

Submarine Emergency valve Controller  
*The Controller must be **opened** both Pumping-In & Pumping -Out working*



**Please Note: When wrench is PARALLEL with pipeline, the pipe flow;  
When wrench is VERTICAL with pipeline, the pipe closed.**

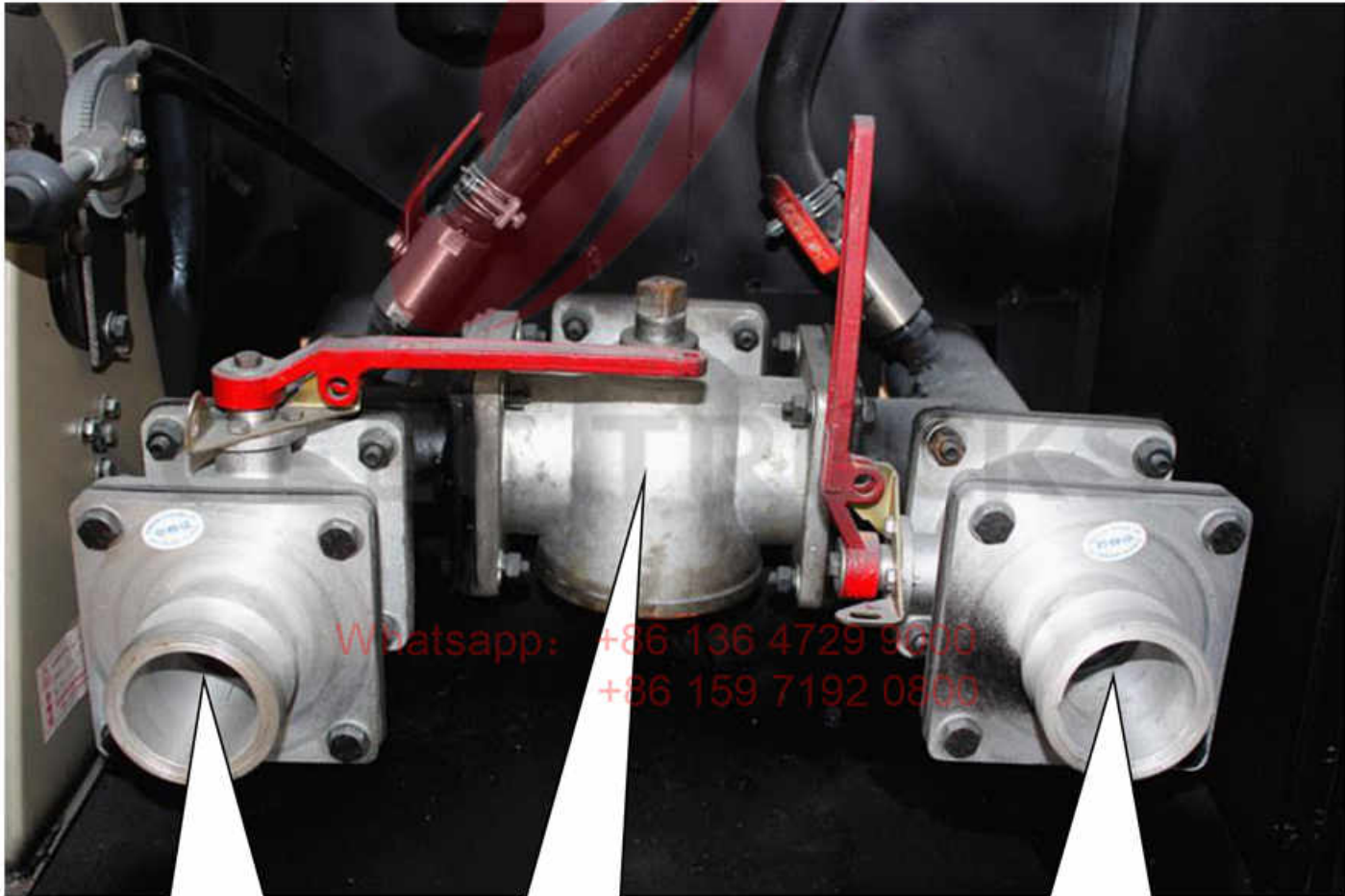

Double-Way Valve #1  
(Entrance)  
Pumping fuel into the tank

Three-Way Ball Valve  
Control fuel in & out of  
the tank

Double-Way Valve #2  
(Exit)  
Pumping fuel out of the tank

2. Read the below Operation Chart carefully before any operation:

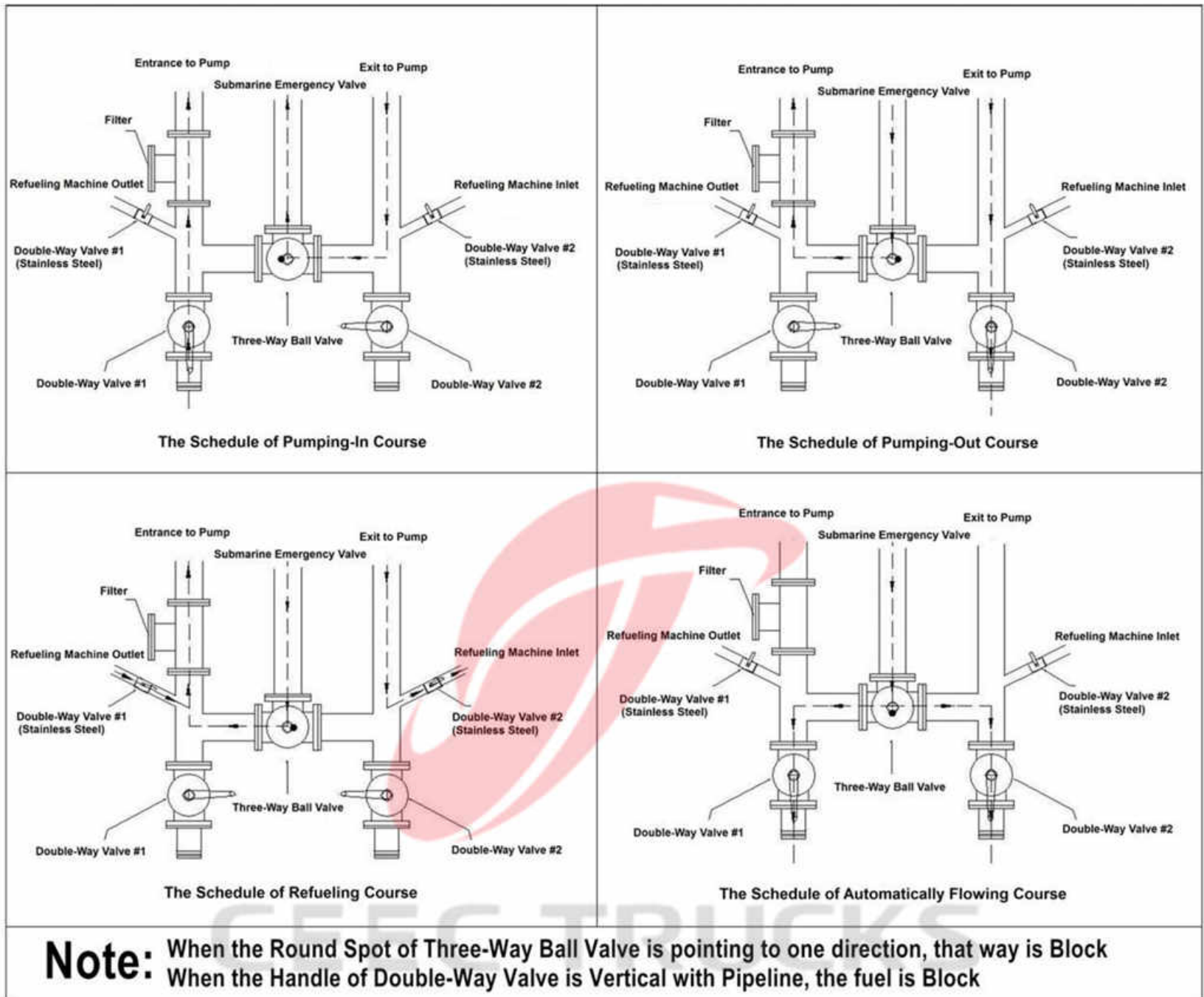

Whatsapp: +86 136 4729 9000  
+86 159 7192 0800

- Before operating valves you should operating the power take off (PTO), the truck transmission gearbox should be in neutral, when the engine is idle, step on the clutch pedal and turn the PTO switch on, and then release the clutch pedal slowly. The fuel pump will start operating.
- Before any other operation, the most important thing is opening the **Submarine Emergency Valve** controller, then the pump pipeline and the fuel tank is unblocked, and the oil can be pinging-in & pumping-out of tank.



c) Special function operation showing as below, which mainly has following four functions:

- **The Schedule of Pumping-In Course:** open **Double-Way Valve #1**, close **Double-Way Valve #2**, and the spot of **Three-Way Ball Valve** pointing to **LEFT** (Means right side is open), both **Double-Way Valve #1 (Stainless Steel)** and **Double-Way Valve #2 (Stainless Steel)** are closed, open the **Submarine Emergency Valve**. Then oil sucked into the pump through **Double-Way Valve #1** under negative pressure of fuel pump, then into the fuel tank.

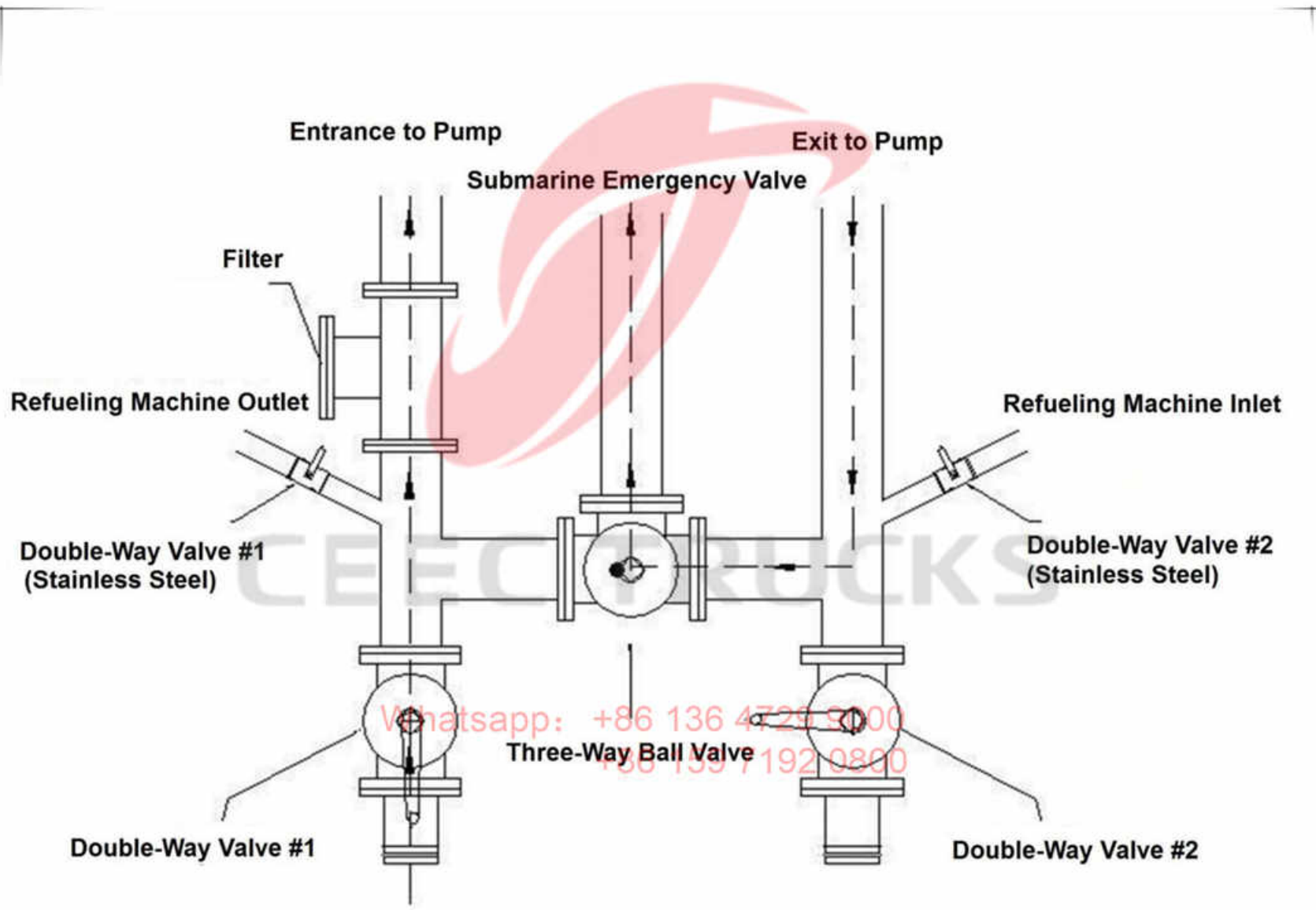

**The Schedule of Pumping-In Course**

- **The Schedule of Pumping-Out Course:** close **Double-Way Valve #1**, open **Double-Way Valve #2**, and the spot of **Three-Way Ball Valve** pointing to **RIGHT** (Means left side is open), both **Double-Way Valve #1 (Stainless Steel)** and **Double-Way Valve #2 (Stainless Steel)** are closed, open the **Submarine Emergency Valve**. Then oil pumping-out of the tank through **Double-Way Valve #2** under negative pressure of fuel pump. Details showing as below chart.

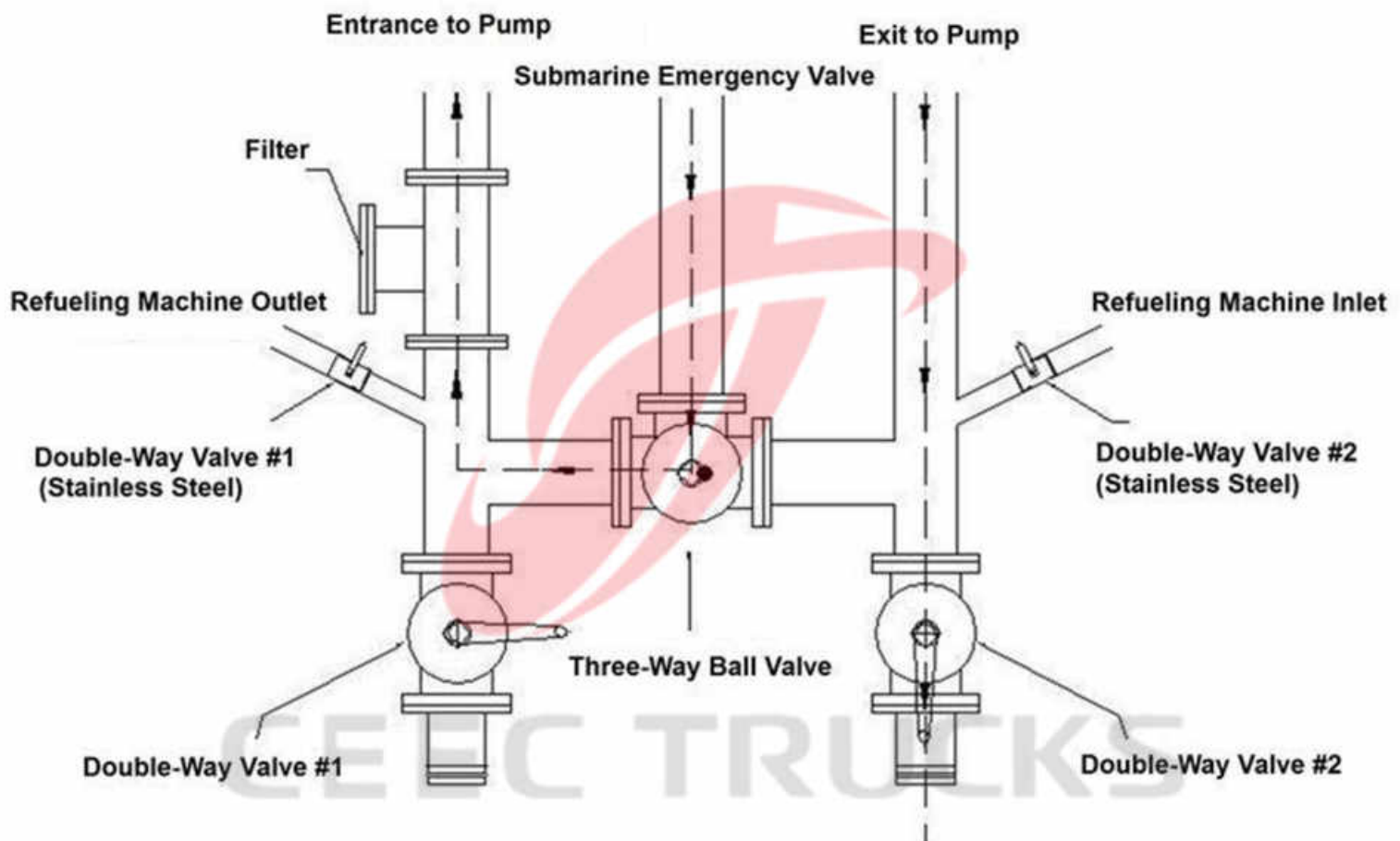

**The Schedule of Pumping-Out Course**

Whatsapp: +86 136 4729 9000  
+86 159 7192 0800



- **The Schedule of Refueling Course:** close **Double-Way Valve #1** and **Double-Way Valve #2**, and the spot of **Three-Way Ball Valve** pointing to **RIGHT** (Means left side is open), both **Double-Way Valve #1 (Stainless Steel)** and **Double-Way Valve #2 (Stainless Steel)** are open, open the **Submarine Emergency Valve**. Then oil can be pumping-into the **CENSTAR Fuel Dispenser** through **Double-Way Valve #2 (Stainless Steel)** under pressure of fuel pump. Then you can operate the **Fuel Dispenser** to refuel all trucks. Details showing as below chart.

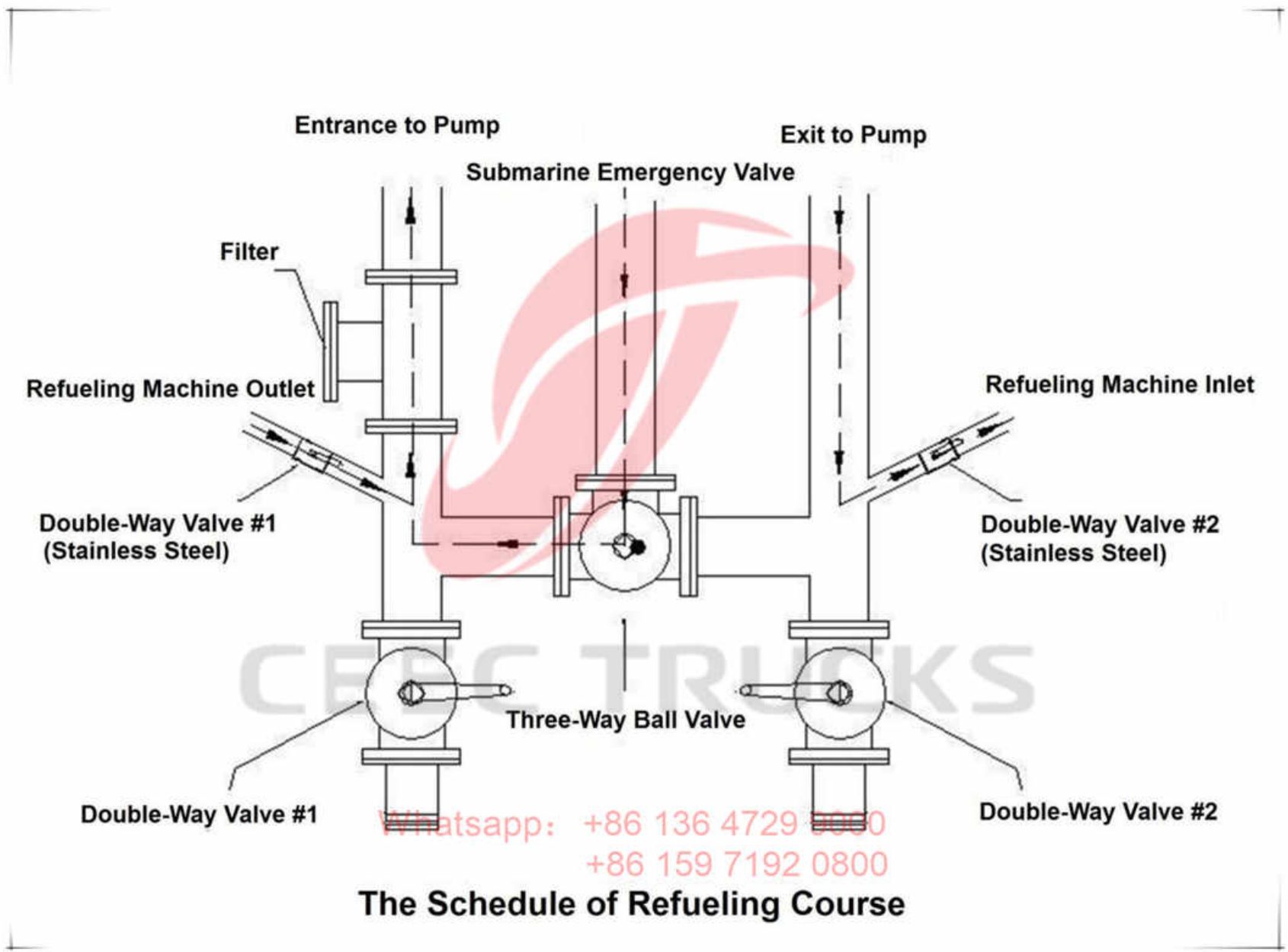

*(Part IV in Chapter 6 will show you more details about how to use CENSTAR Fuel Dispenser)*

- **The Schedule of Automatically Flowing Course:** open **Double-Way Valve #1** and **Double-Way Valve #2**, and the spot of **Three-Way Ball Valve** pointing to **DOWN** position (Means left & right sides are open), both **Double-Way Valve #1 (Stainless Steel)** and **Double-Way Valve #2 (Stainless Steel)** are closed. The **CENSTAR Fuel Dispenser** do not work, just open the **Submarine Emergency Valve**. Then you can operate the **Fuel Dispenser** to refuel all trucks. Details showing as below chart.

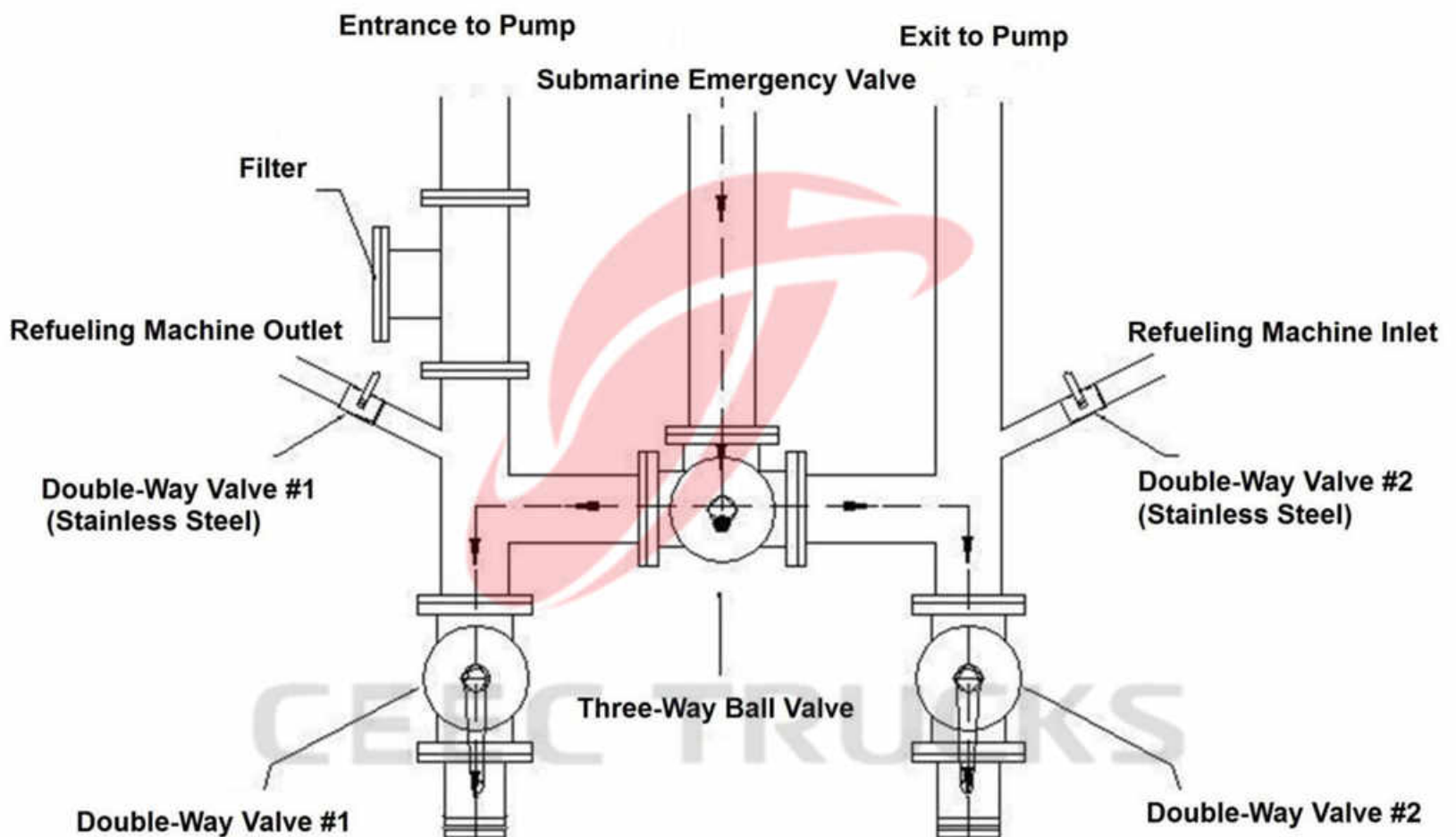

Whatsapp: +86 136 4729 9000  
+86 159 7192 0800

### The Schedule of Automatically Flowing Course



#### IV, How to operate CENSTAR Fuel Dispenser?

Firstly, you should better know the main parts of fuel dispenser.



CEEC TRUCKS

English version Control Panel for reference:



Whatsapp: +86 135 4729 9000  
+86 139 7192 0800

Switch ON / OFF: Pull the Button → ON  
Push the Button → OFF



*Reset Button: Push Down the Button → Reset*

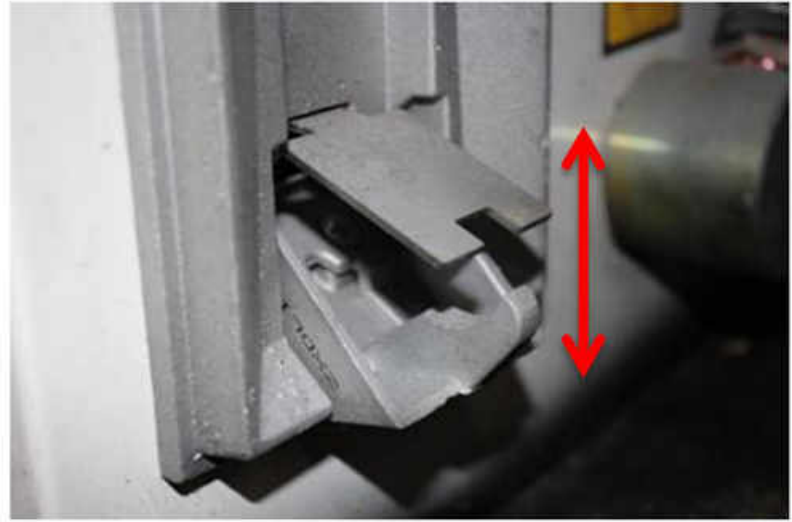

*Refueling Gun: Refueling Operation*



**CEEC TRUCKS**

Whatsapp: +86 136 4729 9000  
+86 159 7192 0800

**Secondly**, you are welcome to start using CENSTAR Fuel Dispenser, Please refer to another document to see how to operate the refueling machine, also know how to maintenance it.



## Chapter 7, Others for Attention

After carefully reading the above information, you must be well known how to use the ISUZU Fuel Tanker Truck; below show some parts you need to pay attention while using the truck.

### i ,Precautions for Use

- Please abide strictly by the following two manuals:
  1. **CENSTAR Fuel Dispenser Manual** (In Cabin)
  2. **Fuel Tanker Truck Owner's Manual**
  
- Carefully examination the fuel truck:
  1. Examine all parts, especially steering device, braking device, Suspension, tires and other joints, etc.
  2. Examine Exhaust Braking System, maintenance if have any leakage.
  3. Examine the tire pressure.
  4. Examine all lights on the truck, including Head Light, Fog Light, Turning Light, Tail Light.
  5. Examine the rear Anti-Static tape, replace it if not tough the ground
  
- It is strictly forbidden to operate the Power Take Off (PTO) under the condition of the clutch not separation (Not step the clutch pedal). When release the clutch, you should slowly. The operation of the PTO must only on the condition of neutral for clutch.

Whatsapp: +86 136 4729 9000  
+86 159 7192 0800
  
- It is better not to do Half-Load transportation, especially for long-distance transport.
  
- When operating all the Valves, it is not good to overexert, for overexert will influence the valve ball's leakproofness. The open & close for Three-Way Valves should completely, and strictly forbidden working when valves not operated completely.

## ii, Maintenance

- The maintenance of the chassis including clutch and transmission gearbox should be properly.
- The maintenance of the fuel dispenser refers to the **"CENSTAR Fuel Dispenser Manual"**.
- The Maintenance of the fuel pump refers to the **"Fuel Tanker Truck Owner's Manual"**.
- It should be checked all coupling and lubrication at fixed period to exclude the tight parts, and make sure all parts in good lubrication condition.
- Both the Fuel Pump, PTO, Transmission Gearbox should be carefully washed, checked and maintenance every year.
- The strainer inside filter should be washed frequently. Exchange it if necessary.

## iii, Spare Parts List

Item	Products Name	Quantity
1	4m long Fuel Pipeline	2 units
2	Standard Tools for chassis	1 set
3	Three-Way Valve Wrence	1 unit

Whatsapp: +86 136 4729 9000  
+86 159 7192 0800